

 Printed on Recycled Paper

 All rights reserved by
ZHEJIANG GENO ELECTRICAL CO.,LTD

GOG electrical

ZHEJIANG GENO ELECTRICAL CO., LTD.

Add:
No.519, 15th Road, Binhai Industrial Area,
Wenzhou, Zhejiang Province, China

Tel:
+86 577 5661 8066
+86 577 5587 5929
+86 577 5661 8052

Email: info@china-gog.com

www.gog-elec.com

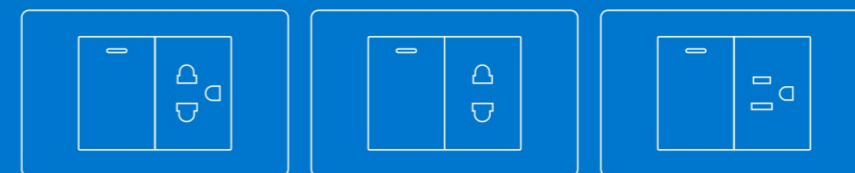

Deliver safety to the world

Catalogue

GOG electrical

ZHEJIANG GENO ELECTRICAL CO., LTD, founded in 2010, is a national high-tech enterprise focusing on household appliances and aesthetic lighting, integrating R&D, manufacturing, trade, service and other functions. The registered capital of the company is 106 million yuan, the plant construction area is more than 100,000 square meters, and more than 2,000 employees.

Main products: switch socket, lamps and lighting, Integrated bath heater, intelligent switch panel, hospital and hotel intelligent, **electrical accessories and other 50 series of more than 1000 varieties of products**, the annual sales of more than 500 million sets, products sold in more than 30 countries and regions around the world.

With a nationwide layout and coordinated development, Geno owns three major automation industry production bases, Wenzhou Electrical production base, Zhongshan Lighting production base and Jiaxing Integrated bath heater production base. It has many subsidiaries including **Geno Electrician, Geno Lighting, Geno Household, Geno Plastic, Geno Alloy, Geno IOT and so on.**



HONOR

Partial



International specialized and special new small giant enterprise
National high-tech enterprises
Zhejiang manufacture "quality" word certification
High performance smart electrical switch Research Institute
Postdoctoral workstation
Scientific and technological innovation enterprise
President Company of Longwan Electrical Appliance Association

QUALIFICATION

Partial



China Green Product Certification
International laboratory accreditation Certificate - CNAS certification
China two integration management system evaluation certificate
ISO 90012015 Quality Management System Certification
ISO 140012015 Environmental Management System certification
ISO 0450012018 Occupational Health and Safety management system certification
AAA level abided by the contract and credit enterprises

PATENTS

Partial



Self-resetting Wall Switch (Invention patent)
Smart control 5 pin socket sensor lamp (Invention patent)
A multifunctional socket capable of adjusting distance (Invention patent)
A power socket with an replaceable sockets modules (Invention patent)
A method for assembling a connect switch base (Invention patent)
A new type of panel (Invention patent)
A smart socket with sensor footlight (invention patent)

GOG electrical

Global Open Genuine

Mission

Deliver safety to hundreds of millions of families around the world

Create value for customers

Help employees develop, Make positive happiness for society

Values

Customer first,
high efficiency, innovation
integrity, responsibility, equality

T SERIES

T-B SERIES

T-C SERIES

T-D SERIES

S SERIES

S SERIES

A SERIES

A10 SERIES

A41 SERIES

A11 SERIES

A50 SERIES

A20 SERIES

A70 SERIES

A22 SERIES

A80 SERIES

A30 SERIES

A81 SERIES

A31 SERIES

A82 SERIES

A40 SERIES

A83 SERIES

C SERIES

C11 SERIES

C12 SERIES

C21 SERIES

C22 SERIES

C31 SERIES

J SERIES

J SERIES

D&Z SERIES

D SERIES

D-2 SERIES

Z SERIES

T SERIES SWITCH SOCKET PRODUCTS

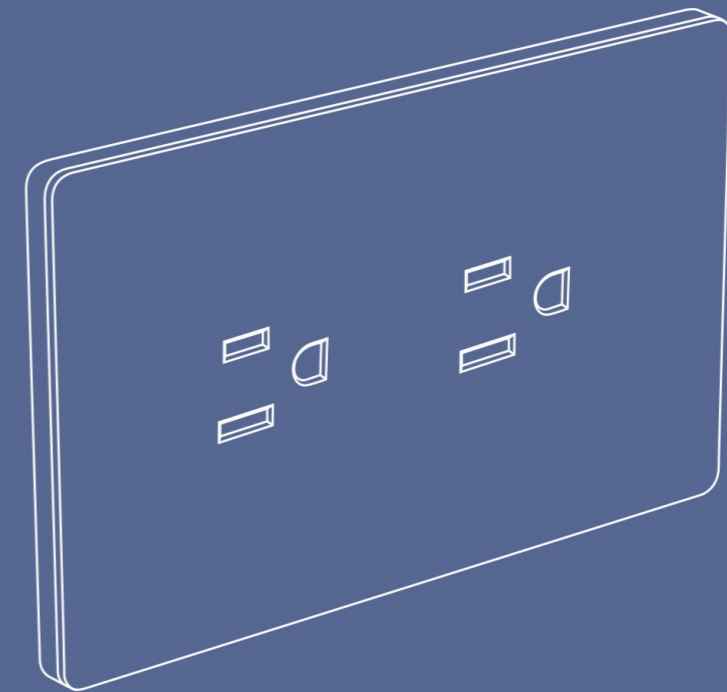

T Series Full Series Showcase

T-B PC SERIES



WHITE

GOLD

GRAY

BLACK

T-B GLASS SERIES



WHITE

GOLD

GRAY

BLACK

T-B STAINLESS STEEL SERIES



SILVERY

GOLD

GRAY

BLACK

T-B ACRYLIC SERIES



MARBLE

WOOD GRAIN

WOOD GRAIN

WIRE DRAWING

T-B Aluminium SERIES

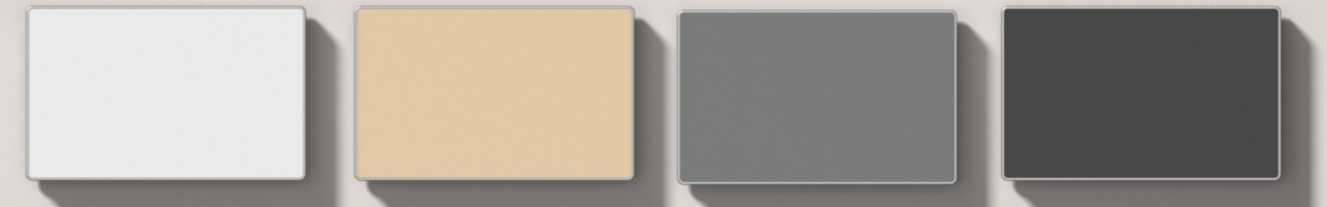

WHITE

GOLD

GRAY

BLACK

T-C Chrome PC SERIES



WHITE

GOLD

GRAY

BLACK

T-C PC SERIES



WHITE

GOLD

GRAY

BLACK

T-D SERIES



WHITE

GOLD

GRAY

BLACK



SMART SWITCH

More aesthetic, more elegant, more function, enables you to fully express your creativity and style. Symbol of lightness, thin and sleek, the new range is a breath of fresh air.



T-B SERIES

Fashionable Frameless Large Panel



T-B SERIES
Human body sensor switch



T-B SERIES
Switch And Socket



T-B GLASS SERIES

Switch And Socket

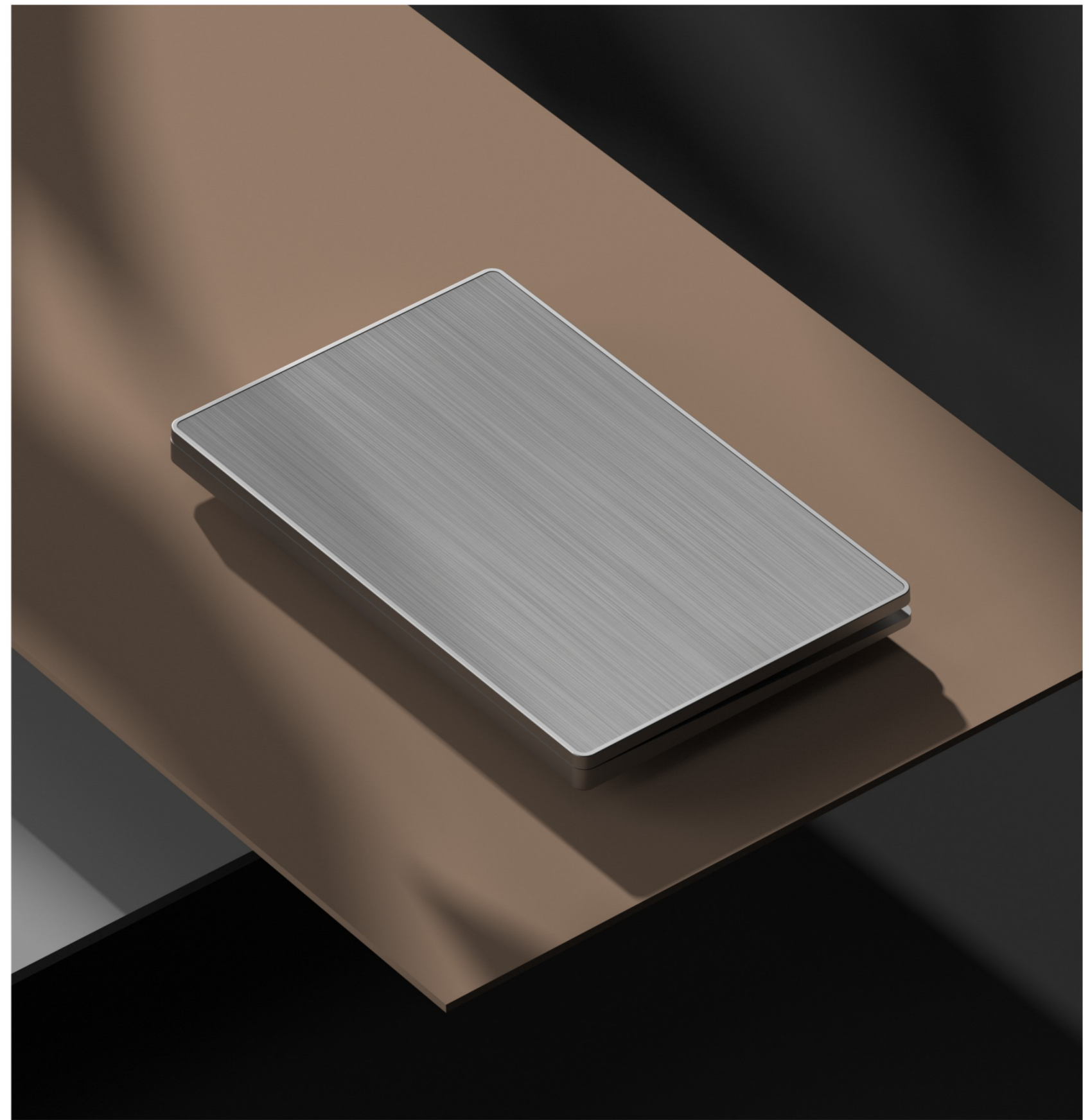

T-B STAINLESS STEEL SERIES

Switch And Socket



T-B ACRYLIC SERIES

Switch And Socket



T-B ALUMINIUM SERIES

Switch And Socket

Ultra thin Only 7.5mm

2.5°
Small Angle switch

7.5mm
Ultra thin

200,000+
Working life



1 gang 2 way switch

- 01 High strength and highlight fire-retardant PC cover
- 02 Thicken painted metal frame, more stronger and not deform
- 03 I shape moving part, Single-stage driving
- 04 High strength and highlight fire-retardant PC cover
- 05 New rocker board with fixed bracket structure, performance is more stable, hand feeling is more smooth

Duplex socket

- 01 High strength and highlight fire-retardant PC cover
- 02 Thicken painted metal frame, more stronger and not deform
- 03 High strength and highlight fire-retardant PC cover
- 04 Fiberglass reinforced PA safety door
- 05 0.7mm phosphor copper, strong elastic, pull-out force more better

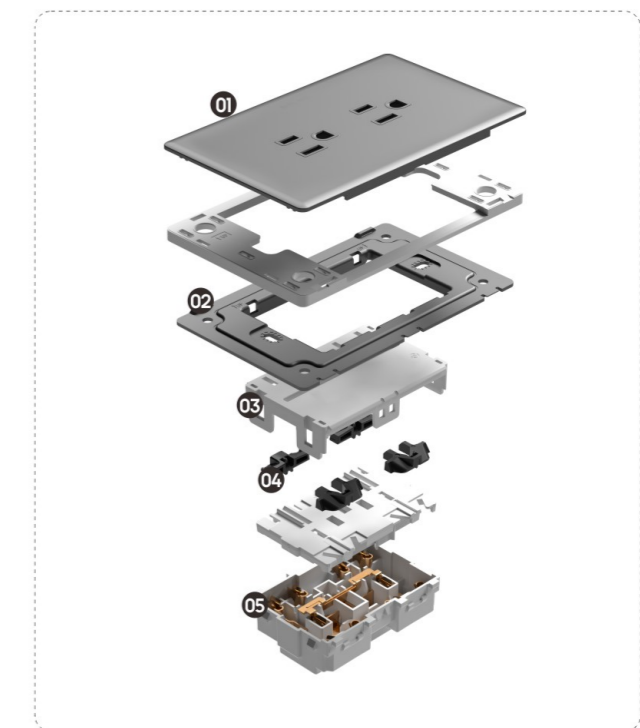
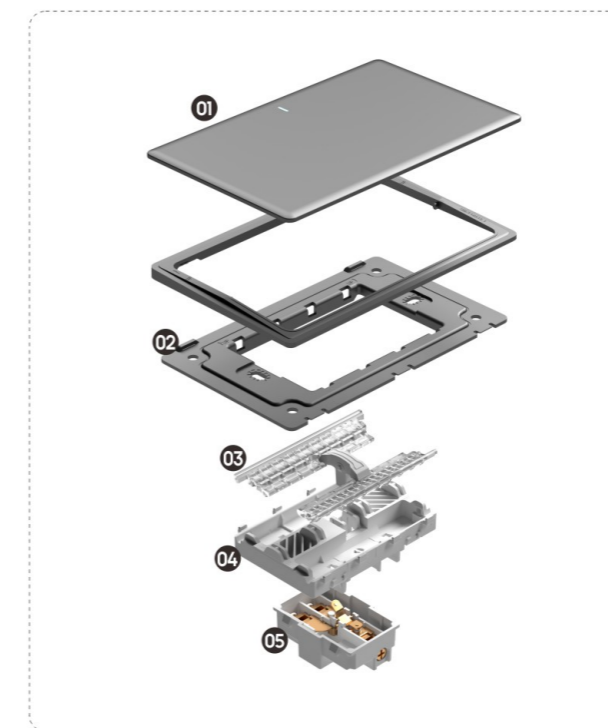

T-B SERIES

SWITCH PRODUCTS



TB115/125
1 gang 1 way switch (L)
1 gang 2 way switch (L)



TB215/225
2 gang 1 way switch (L)
2 gang 2 way switch (L)



TB315/325
3 gang 1 way switch (L)
3 gang 2 way switch (L)



TB105
Doorbell switch (L)



TBMB25
2 pin socket (L)



TBM35
3 pin socket (L)



TB11M35/TB12M35
1 gang 1 way switch with 3P socket (L)
1 gang 2 way switch with 3P socket (L)



TB11M65/TB12M65
1 gang 1 way switch with Duplex 3P socket (L)
1 gang 2 way switch with Duplex 3P socket (L)



TBM65
Duplex 3P socket (L)
Duplex 3P socket (L)

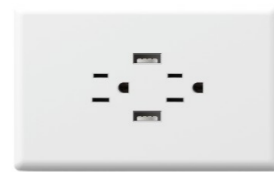

TBM6UA5
Duplex 3P socket + 2USB (L)



TBM6UC5
Duplex 3P socket with USB (A+C) (L)



TBT35
3P socket (L)



TB11T35
1 gang 1 way switch with 3P socket (L)



TB12T35
1 gang 2 way switch with 3P socket (L)



TBT65
Duplex 3P socket (L)



TBWX5/DS5
Satellite socket (L)
TV socket (L)



TBDF5/DN5
TEL socket (L)
Computer socket (L)



TBWXDF5/WXDN5
Satellite and TEL socket (L)
Satellite and Computer socket (L)



TBTG5/TBTS5
Dimmer light (L)
Dimmer fan (L)



TBKB5
Blank plate (L)

T-B SERIES

SOCKET PRODUCTS



TB113/123
1 gang 1 way switch (3/3)
1 gang 2 way switch (3/3)



TB1101/1201
1 gang 1 way switch (1/3)
1 gang 2 way switch (1/3)



TB213/223
2 gang 1 way switch (3/3)
2 gang 2 way switch (3/3)



TB212/222
2 gang 1 way switch (1/3)
2 gang 2 way switch (1/3)



TB313/323
3 gang 1 way switch
3 gang 2 way switch



TB413/423
4 gang 1 way switch
4 gang 2 way switch



TB103
Doorbell switch (3/3)

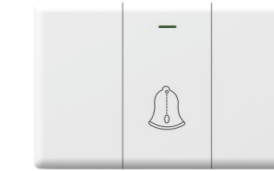

TB102
Doorbell switch (1/2)



TB1001
Doorbell switch (1/3)



TBM63
Triple 2P socket



TB11M32/12M32
1 gang 1 way switch with 3P socket (1/3)
1 gang 2 way switch with 3P socket (1/3)



TB21M33/22M33
2 gang 1 way switch with 3P socket
2 gang 2 way switch with 3P socket



TB11M63/12M63
1 gang 1 way switch with 2 gang 3P socket
1 gang 2 way switch with 2 gang 3P socket

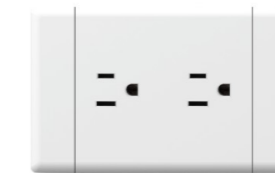

TBM63
Duplex 3P socket



TBM93
3 gang 3P socket



TBM3UA2
3P socket with 2USB (1/3)



TBM3UC2
3P socket with USB (A+C) (1/3)

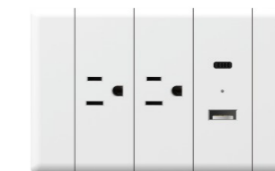

TBM3M3UC3
2 gang 3P socket with USB (A+C)



TBM3UC2/3
3P socket with USB (A+C) (2/3)

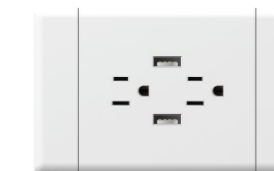

TBM6UA3
Duplex 3P socket with 2USB

T-B SERIES

SOCKET PRODUCTS

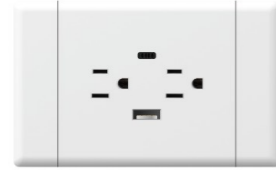

TBM6UC3
Duplex 3P socket with USB (A+C)



TB11T32/12T32
1 gang 1 way switch with 3P socket (1/3)
1 gang 2 way switch with 3P socket (1/3)



TBT63
Duplex 3P socket



TBT93
3 gang 3P socket



TBT3UC2
3P socket with USB (A+C) (1/3)



TBT3T3UC3
2 gang 3P socket with USB (A+C)



TBT3UC2/3
3P socket with USB (A+C) (2/3)



TBT6UA3
Duplex 3P Socket with 2USB

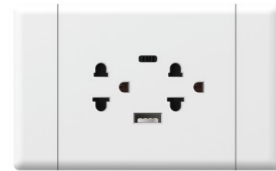

TBT6UC3
Duplex 3P Socket with USB (A+C)



TB11BD22/12BD22
1 gang 1 way switch with 2P +E socket
1 gang 2 way switch with 2P +E socket



TB11B22/12B22
1 gang 1 way switch with 2P socket (1/ 3)
1 gang 2 way switch with 2P socket t (1/ 3)



TBB63
Triple 2P socket



TBB2UA2
2P socket with 2 USB (1/3)



TBB2UC2
2P socket with USB (A+C) (1/3)

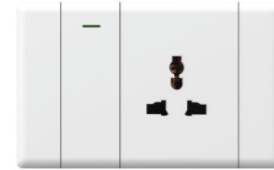

TB11D32/3
1 gang 1 way switch with 3 PIN MF socket (2/3)
1 gang 2 way switch with 3 PIN MF socket (2/3)



TB11Y22/12Y22
1 gang 1 way switch with 2P socket (1/3)
1 gang 2 way switch with 2P socket (1/3)



TB11Y32/12Y32
1 gang 1 way switch with 3P socket (1/3)
1 gang 2 way switch with 3P socket (1/3)



TB11YD32/12YD32
1 gang 1 way switch with 2P+T socket (1/3)
1 gang 2 way switch with 2P+T socket (1/3)



TBYD93
Triple socket 2P+T



TB11BX2/12BX2
1 gang 1 way switch with 3P socket (1/3)
1 gang 2 way switch with 3P socket (1/3)

T-B SERIES

INFORMATION PRODUCTS



TBBX93
3 gang 3P socket

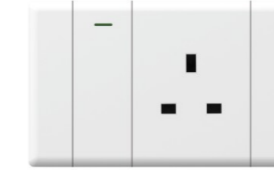

TB11YS2/3 TB12YS2/3
1 gang 1 way switch with 13A socket (2/3)
1 gang 2 way switch with 13A socket (2/3)

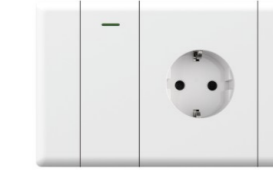

TB11O22/3 TB12O22/3
1 gang 1 way switch with European socket (2/3)
1 gang 2 way switch with European socket (2/3)



TB11TG2/12TG2/11TS2/12TS2
1 gang 1 way switch dimmer light (1/3)
1 gang 2 way switch dimmer light (1/3)
1 gang 1 way switch dimmer fan (1/3)
1 gang 2 way switch dimmer fan (1/3)



TBTG01/TS01
Dimmer light switch (1/3)
Dimmer fan switch (1/3)



TBDS01
TV socket (1/3)



TBWX01
Satellite socket (1/3)



TBDF01/DN01
TEL socket (1/3)
Computer socket (1/3)



TBDF22/DN22/DFDN2
Double TEL socket (1/3)
Double Computer socket (1/3)
TEL and Computer socket (1/3)



TBWXDF2/WXDN2
Satellite and TEL socket (1/3)
Satellite and Computer socket (1/3)

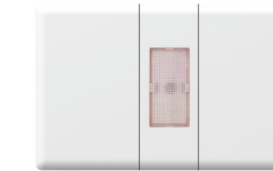

TBZS01
Indicator (1/3)



TBCL01
Curtain switch (1/3)



TBYP01
3 way loudspeaker (1/3)



TBUA01
2 USB socket (1/3)



TBUC01
USB (A+C) (1/3)



TBRT01
Human body sensor switch (1/3)



TBB2WUC2/3
2P socket with wire USB (A+C) (2/3)



TBRTH3
Human body sensor switch (3/3)

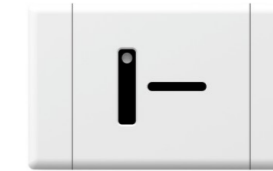

TBRTS3
Human body sensor switch (3/3)



TBKB01
Blank panel (1/3)

T-B SERIES

module



TBM113/3
TBM123/3
 1 gang 1 way switch (3/3)
 1 gang 2 way switch (3/3)

TBM111/2
TBM121/2
 1 gang 1 way switch (1/2)
 1 gang 2 way switch (1/2)

TBM111/3 **TBM121/3**
TBM131/3
 1 gang 1 way switch (1/3)
 1 gang 2 way switch (1/3)
 1 gang 3 way switch (1/3)

TBM211/2 **TBM221/2**
TBM211/3 **TBM221/3**
 2 gang 1 way switch (1/2)
 2 gang 2 way switch (1/2)
 2 gang 1 way switch (1/3)
 2 gang 2 way switch (1/3)

TBM103/3
 Doorbell switch (3/3)

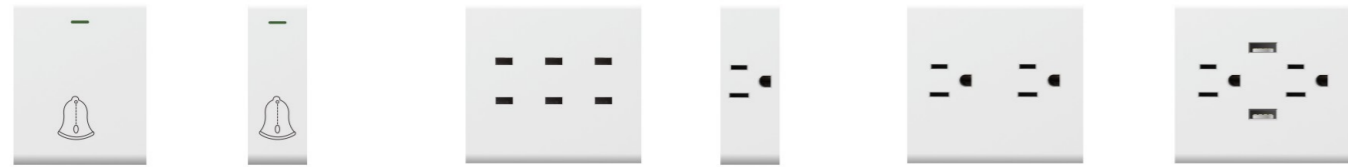

TBM101/2
 Doorbell switch (1/2)

TBM101/3
 Doorbell switch (1/3)

TBMMB63/3
 Triple 2P socket (3/3)

TBMM31/3
 3P socket (1/3)

TBMM63/3
 Duplex 3P socket (3/3)

TBMM6UA3/3
 Duplex 3P socket with 2USB (3/3)



TBMM6UC3/3
 Duplex 3P socket with USB (A+C) (3/3)

TBMT31/3
 3P socket (1/3)

TBMT63/3
 Duplex 3P socket (3/3)

TBMT6UA3/3
 Duplex socket 3P with 2USB

TBMT6UC3/3
 Duplex socket 3P with USB (A+C)



TBMBD21/3
 2P+E socket (1/3)

TBMB21/3
 2P socket (1/3)

TBMB63/3
 Triple 2P socket (3/3)

TBMD32/3
 3P MF socket (2/3)

TBMY21/3
 2P socket (1/3)

TBMY31/3
 3P socket (1/3)

T-B SERIES

module



TBMYD31/3
 2P+T socket (1/3)

TBMBX1/3
 3P socket (1/3)

TBMY2/3
 13A socket (2/3)

TBMO22/3
 European socket (2/3)

TBMDS1/3
 TV socket (1/3)

TBMWX1/3
 Satellite socket (1/3)

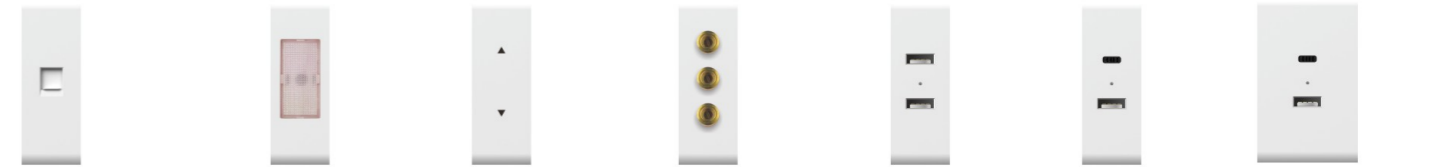

TBMDF1/3 **TBMDN1/3**
 TEL socket (1/3)
 Computer socket (1/3)

TBMZS1/3
 Indicator socket (1/3)

TBMCL1/3
 Curtain switch (1/3)

TBMP1/3
 3 way loudspeaker (1/3)

TBMUA1/3
 2USB socket (1/3)

TBMUC1/3
 USB (A+C) socket (1/3)

TBMUC1/2
 USB (A+C) socket (1/2)



TBMUC2/3
 USB (A+C) socket (2/3)

TBMTG1/3 **TBMTS1/3**
 Dimmer light (1/3)
 Dimmer fan (1/3)

TBMRT1/3
 Human body sensor switch (1/3)

TBMKB1/3
 Blank (1/3)

TBB2WUC2/3
 2P socket with wire USB (A+C) (2/3)

TBRTH3
 Human body sensor switch (3/3)



TBRTS3
 Human body sensor switch (3/3)

TBP01
 1 gang wall plate (1/3)

TBP2
 2 gang wall plate (1/3)

TBP3
 3 gang wall plate (3/3)

T-C SERIES

T-C SERIES

SWITCH AND SOCKET PRODUCTS

Appreciating Minimalist Design

The true colors of elegance with ultra-thin design, minimal geometry and an array of colors and finishes, including grey, black, and gold. Wiring devices blend in or stand out elegantly in any decor.



TC115/125
1 gang 1 way switch (L)
1 gang 2 way switch (L)



TC215/225
2 gang 1 way switch (L)
2 gang 2 way switch (L)



TC315/325
3 gang 1 way switch (L)
3 gang 2 way switch (L)

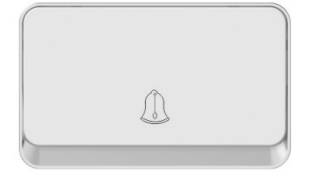

TC105
Doorbell switch (L)



TCM35
3 pin socket (L)



TC11M35
1 gang 1 way switch with 3P socket (L)



TC12M35
1 gang 2 way switch with 3P socket (L)



TC11M65
1 gang 1 way switch with Duplex 3P socket (L)



TC12M65
1 gang 2 way switch with Duplex 3P socket (L)



TCM65
Duplex 3P socket (L)

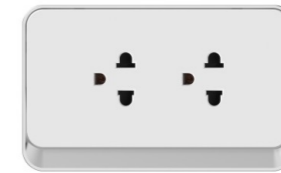

TCT65
Duplex 3P socket (L)



TCDS5
TV socket (L)

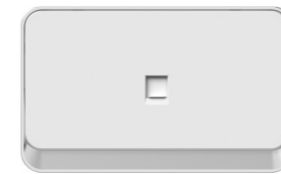

TCDF5/DN5
TEL socket (L)
Computer socket (L)



TCDSDF5/DSDN5
TV and TEL socket (L)
TV and Computer socket (L)



TCTG5
Dimmer light switch (1/3)

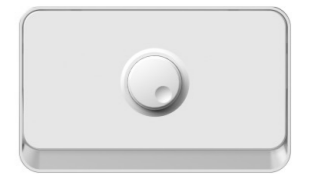

TCTS5
Dimmer fan switch (1/3)

T-D SERIES



Appreciating Minimalist Design

The true colors of elegance with ultra-thin design, minimal geometry and an array of colors and finishes, including grey, black, and gold. Wiring devices blend in or stand out elegantly in any decor.

T-D SERIES

SWITCH AND SOCKET PRODUCTS

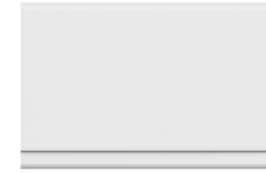

TC115/125
1 gang 1 way switch (L)
1 gang 2 way switch (L)



TC215/225
2 gang 1 way switch (L)
2 gang 2 way switch (L)



TC315/325
3 gang 1 way switch (L)
3 gang 2 way switch (L)



TC105
Doorbell switch (L)

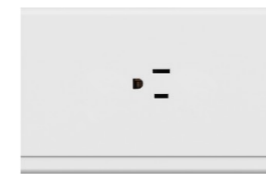

TCM35
3 pin socket (L)



TC11M35
1 gang 1 way switch with 3P
socket (L)



TC12M35
1 gang 2 way switch with 3P
socket (L)



TC11M65
1 gang 1 way switch with Duplex 3P
socket (L)



TC12M65
1 gang 2 way switch with Duplex 3P
socket (L)



TCM65
Duplex 3P socket (L)
Duplex 3P socket (L)



TCT65
Duplex 3P socket (L)



TCDS5
TV socket (L)

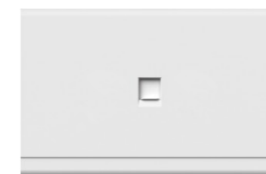

TCDF5/DN5
TEL socket (L)
Computer socket (L)

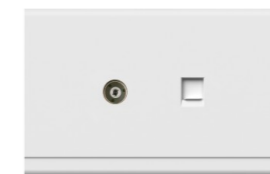

TCDSDF5/DSDN5
TV and TEL socket (L)
TV and Computer socket (L)



TCTG5
Dimmer light switch (1/3)



TCTS5
Dimmer fan switch (1/3)

S SERIES SWITCH SOCKET PRODUCTS

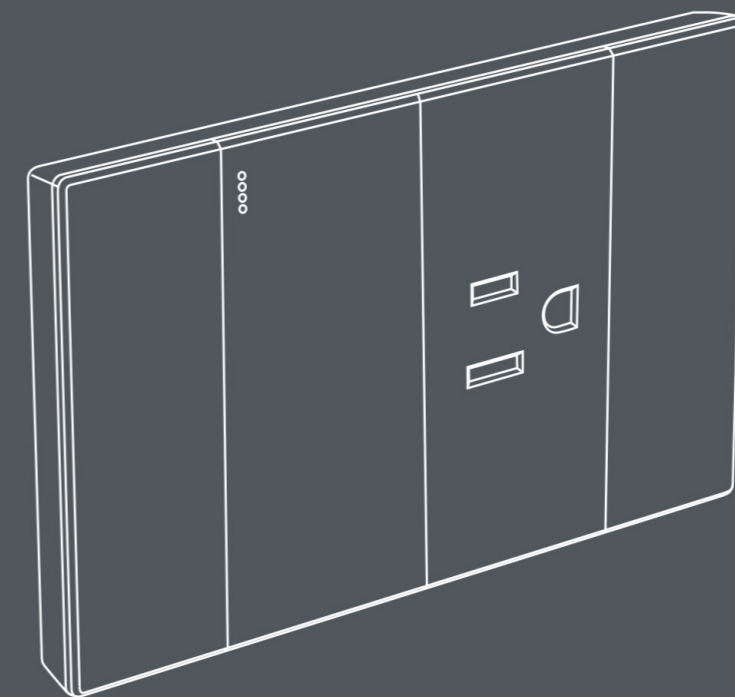

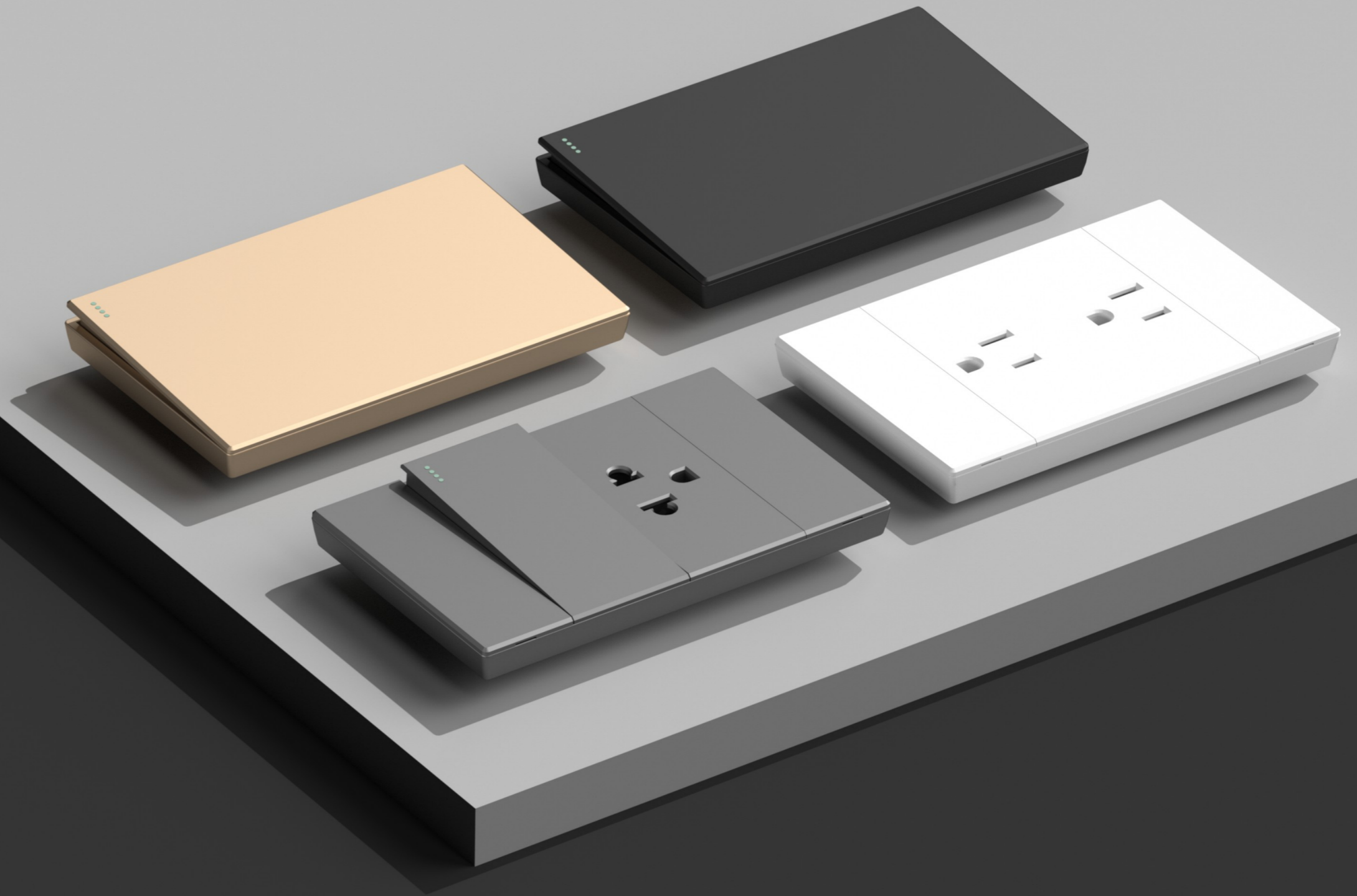

S SERIES

STYLISH APPEARANCE AND ELEGANT STYLE

Colourful at first sight trend-setting aesthetics that fit closely to the wall and give you visual pleasure fantastic colours, stunning at first sight The colours are fresh, natural and full of highlights right out of the box.

S SERIES

SWITCH PRODUCTS

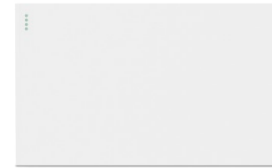

S115/125
1 gang 1 way switch (L)
1 gang 2 way switch (L)



S215/225
2 gang 1 way switch (L)
2 gang 2 way switch (L)



S315/325
3 gang 1 way switch (L)
3 gang 2 way switch (L)



S113/123
1 gang 1 way switch (3/3)
1 gang 2 way switch (3/3)



S111/121
1 gang 1 way switch (1/2)
1 gang 2 way switch (1/2)



S1101/1201/1301
1 gang 1 way switch (1/3)
1 gang 2 way switch (1/3)
1 gang 3 way switch (1/3)



S213/223
2 gang 1 way switch (3/3)
2 gang 2 way switch (3/3)



S212/222
2 gang 1 way switch (1/3)
2 gang 2 way switch (1/3)



S313/323
3 gang 1 way switch
3 gang 2 way switch



S413/423
4 gang 1 way switch
4 gang 2 way switch



S613/623
6 gang 1 way switch (3/3)
6 gang 2 way switch (3/3)



S414/424
4gang 1 way switch (1/3*4)
4 gang 2 way switch (1/3*4)



S616/626
6 gang 1 way switch (1/3*6)
6 gang 2 way switch (1/3*6)

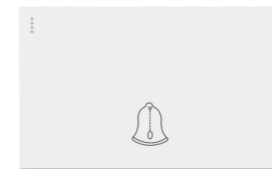

S105
Doorbell switch (L)



S101
Doorbell switch (1/2)



S1001
Doorbell switch (1/3)



S323/453
32A switch (3/3)
45A switch (3/3)



S2001
20A switch (1/3)

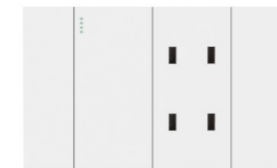

S11MB43/12MB43
1 gang 1 way switch with Duplex 2P socket
1 gang 2 way switch with Duplex 2P socket

S SERIES

SOCKET PRODUCTS

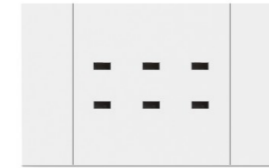

SMB63
Triple 2P socket



S11M33/12M33
1 gang 1 way switch with 3P socket (3/3)
1 gang 2 way switch with 3P socket (3/3)



S11M32/12M32
1 gang 1 way switch with 3P socket (1/3)
1 gang 2 way switch with 3P socket (1/3)



S21M33/22M33
2 gang 1 way switch with 3P socket
2 gang 2 way switch with 3P socket



S11M63/12M63
1 gang 1 way switch with 2 gang 3P socket
1 gang 2 way switch with 2 gang 3P socket



SM63
Duplex 3P socket



SM93
3 gang 3P socket



SM3UC3
3P socket with USB (A+C) (3/3)



SM3UC2
3P socket with USB (A+C) (1/3)



SM3UC43
3P socket with 2 USB (A+C) (3/3)



SM3M3UC3
2 gang 3P socket with USB (A+C)



SM6UA3
Duplex 3P socket with 2USB



SM6UC3
Duplex 3P socket with USB (A+C)

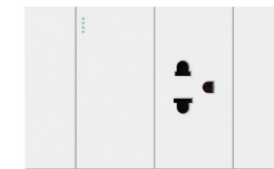

S11T33/12T33
1 gang 1 way switch with 3P socket (3/3)
1 gang 2 way switch with 3P socket (3/3)



S11T32/12T32
1 gang 1 way switch with 3P socket (1/3)
1 gang 2 way switch with 3P socket (1/3)



ST63
Duplex 3P socket



ST93
3 gang 3P socket



ST3UC3
3P socket with USB (A+C) (3/3)



ST3UC2
3P socket with USB (A+C) (1/3)

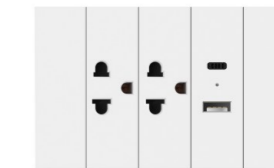

ST3T3UC3
2 gang 3P socket with USB (A+C)

S SERIES

SOCKET PRODUCTS

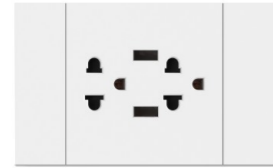

ST6UA3
Duplex 3P socket with 2USB



S11BD22/12BD22
1 gang 1 way switch with 2P+E socket (1/3)
1 gang 2 way switch with 2P+E socket (1/3)



S11B23/12B23
1 gang 1 way switch with 2P socket (3/3)
1 gang 2 way switch with 2P socket (3/3)



S11B43/12B43
1 gang 1 way switch with Duplex 2P socket
1 gang 2 way switch with Duplex 2P socket



S11B22/12B22
1 gang 1 way switch with 2P socket (1/3)
1 gang 2 way switch with 2P socket (1/3)



S11B43/12B43
1 gang 1 way switch with 2 gang 2P socket
1 gang 2 way switch with 2 gang 2P socket



SB63
Triple 2P socket



SB2UA3
2P socket with 2USB (3/3)



SB2UA2
2P socket with 2USB (1/3)



SB2UC3
2P socket with USB (A+C) (3/3)



SB2UC2
2P socket with USB (A+C) (1/3)



SB4UC3
2 gang 2P socket with USB (A+C) (3/3)

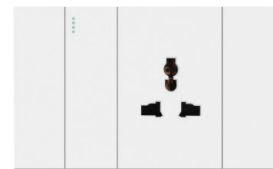

S11D32/3 S12D32/3
1 gang 1 way switch with 3P MF socket (2/3)
1 gang 2 way switch with 3P MF socket (2/3)

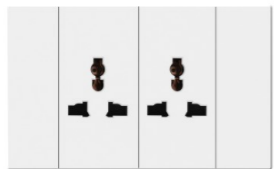

SD63
2 gang 3P MF socket



S11Y22/12Y22
1 gang 1 way switch with 2P socket (1/3)
1 gang 2 way switch with 2P socket (1/3)



S11Y33/12Y33
1 gang 1 way switch with 3P socket (3/3)
1 gang 2 way switch with 3P socket (3/3)



S11Y32/12Y32
1 gang 1 way switch with 3P socket (1/3)
1 gang 2 way switch with 3P socket (1/3)



S11YD33/12YD33
1 gang 1 way switch with 2P+T socket (3/3)
1 gang 2 way switch with 2P+T socket (3/3)



S11YD32/12YD32
1 gang 1 way switch with 2P+T socket (1/3)
1 gang 2 way switch with 2P+T socket (1/3)



SYD93
Triple 2P+T socket

S SERIES

INFORMATION PRODUCTS



S11BX2/12BX2
1 gang 1 way switch with 3P socket (1/3)
1 gang 2 way switch with 3P socket (1/3)

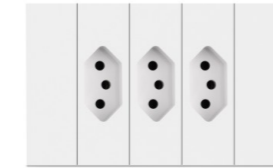

SBX93
3 gang 3P socket

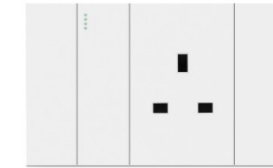

S11YS2/3 S12YS2/3
1 gang 1 way switch with 13A socket (2/3)
1 gang 2 way switch with 13A socket (2/3)



S11O22/3 S12O22/3
1 gang 1 way switch with European socket (2/3)
1 gang 2 way switch with European socket (2/3)



S11TG2/12TG2/11TS2/12TS2
1 gang 1 way switch dimmer light (1/3)
1 gang 2 way switch dimmer light (1/3)
1 gang 1 way switch dimmer fan (1/3)
1 gang 2 way switch dimmer fan (1/3)



STG01/TS01
dimmer light switch (1/3)
dimmer fan switch (1/3)

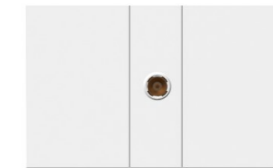

SDS01
TV socket (1/3)

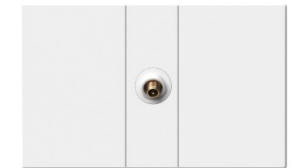

SWX01
Satellite socket (1/3)

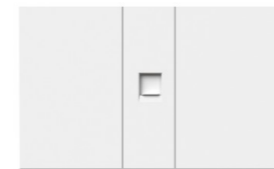

SDF01/DN01
TEL socket (1/3)
Computer socket (1/3)



SDF22/DN22/DFDN2
Double TEL socket (1/3)
Double Computer socket (1/3)
TEL and Computer socket (1/3)

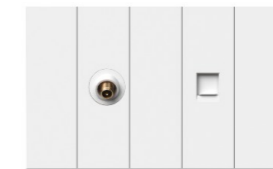

SWXDF2/WXDN2
Satellite and TEL socket (1/3)
Satellite and Computer socket (1/3)



SZS01
Indicator (1/3)



SCL01
Curtain switch (1/3)

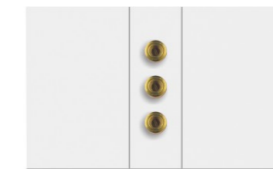

SYP01
3 way loudspeaker (1/3)



SUC01
USB (A+C) (1/3)



SUC1
USB (A+C) (1/2)



SB2WUC2/3
2P socket with wire USB (A+C) (2/3)

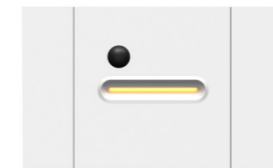

SRTH3
Human body sensor switch (3/3)



SRTS3
Human body sensor switch (3/3)

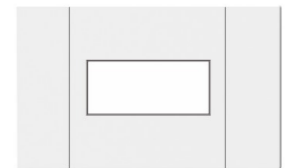

S1P3/2P3/3P3
1P (3/3)
2P (3/3)
3P (3/3)

S SERIES

module



**SM113/3
SM123/3**
1 gang 1 way switch (3/3)
1 gang 2 way switch (3/3)



**SM111/2
SM121/2**
1 gang 1 way switch (1/2)
1 gang 2 way switch (1/2)



**SM111/3
SM121/3
SM131/3**
1 gang 1 way switch (1/3)
1 gang 2 way switch (1/3)
1 gang 3 way switch (1/3)



**SM211/2
SM221/2**
2 gang 1 way switch (1/2)
2 gang 2 way switch (1/2)



**SM211/3
SM221/3**
2 gang 1 way switch (1/3)
2 gang 2 way switch (1/3)



SM103/3
Doorbell switch (3/3)



SM101/2
Doorbell switch (1/2)



SM101/3
Doorbell switch (1/3)



**SM323/3
SM453/3**
32A switch (3/3)
45A switch (3/3)



SM201/3
20A switch (1/3)



SMMB41/2
Duplex 2P socket (1/2)



SMMB63/3
Triple 2P socket (3/3)



SMM31/3
3P socket (1/3)



SMM31/2
3P socket (1/2)



SMM63/3
Duplex 3P socket (3/3)



SMM6UA3/3
Duplex 3P socket
with 2USB (3/3)



SMM6UC3/3
Duplex 3P socket
with USB (A+C) (3/3)



SMT31/3
3P socket (1/3)



SMT31/2
3P socket (1/2)



SMT63/3
Duplex 3P socket (3/3)



SMT6UA3/3
Duplex socket 3P
with 2USB



SMBD21/3
2P+E socket (1/3)



SMBD21/2
2P +E socket (1/2)



SMB21/3
2P socket (1/3)



SMB21/2
2P socket (1/2)



SMB41/2
Duplex 2P socket (1/2)



SMB63/3
Triple 2P socket (3/3)



SMD31/2
3P MF socket (1/2)



SMD32/3
3P MF socket (2/3)



SMY21/3
2P socket (1/3)



SMY21/2
2P socket (1/2)



SMY31/3
3P socket (1/3)



SMY31/2
3P socket (1/2)



SMYD31/3
2P+T socket (1/3)



SMYD31/2
2P+T socket (1/2)



SMBX1/3
3P socket (1/3)



SMYS1/2
13A socket (1/2)



SMYS2/3
13A socket (2/3)



SMO22/3
European socket (2/3)

S SERIES

module

S SERIES

module



SMDS1/3
TV socket (1/3)



SMDS1/2
TV socket (1/2)



SMWX1/3
Satellite socket (1/3)



SMWX1/2
Satellite socket (1/2)



SMDF1/3
SMDN1/3
TEL socket (1/3)
Computer socket (1/3)



SMDF1/2
SMDN1/2
TEL socket (1/2)
Computer socket (1/2)



SMYP1/3
3 way loudspeaker (1/3)



SMYP1/2
3 way loudspeaker (1/2)



SMZS1/3
Indicator socket (1/3)



SMZS1/2
Indicator socket (1/2)



SMUA1/3
2USB socket (1/3)



SMUA1/2
2USB socket (1/2)



SMUC1/3
USB (A+C)
socket (1/3)



SMUC1/2
USB (A+C)
socket (1/2)



SMUC2/3
USB (A+C)
socket (2/3)



SMTG1/3
SMTS1/3
Dimmer light (1/3)
Dimmer fan (1/3)



SMTG1/2
SMTS1/2
Dimmer light (1/2)
Dimmer fan (1/2)



SMCL1/3
Curtain switch (1/3)



SMFM1/3
Buzer (1/3)



SMKB1/3
Blank (1/3)



SMKB1/2
Blank (1/2)



SB2WUC2/3
2P socket with wire
USB (A+C) (2/3)



SRTH3
Human body sensor
switch (3/3)



SRTS3
Human body sensor
switch (3/3)



SM1P3/3
1P (3/3)



SM2P3/3
2P (3/3)



SM3P3/3
3P (3/3)



SP01
1 gang wall plate (1/3)



SP1
1 gang wall plate (1/2)



SP2
2 gang wall plate (1/3)



SP3
3 gang wall plate (3/3)



SP4
4 gang wall plate



SP6
6 gang wall plate

S SERIES

module

A SERIES SWITCH SOCKET PRODUCTS

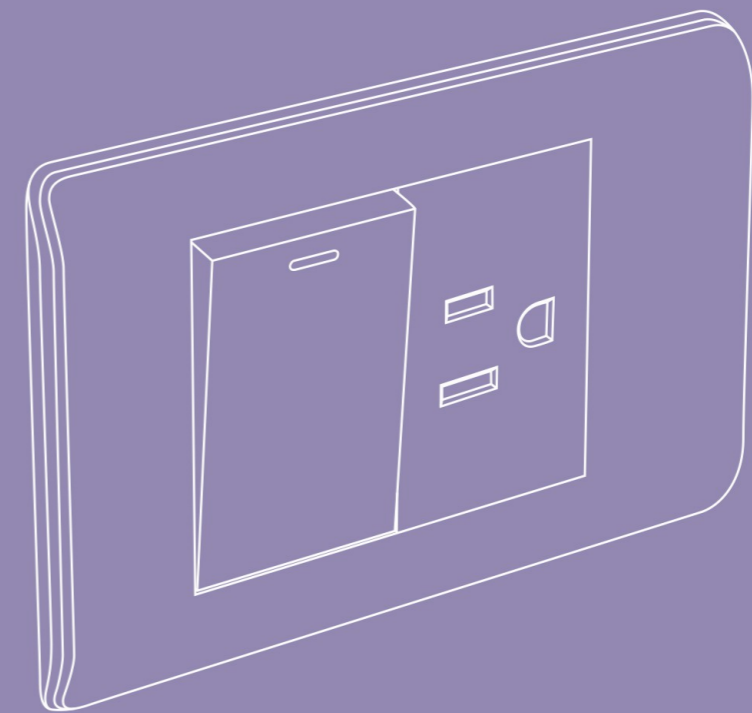

GOGelectrical

A Series Full Series Showcase

A10 PC SERIES

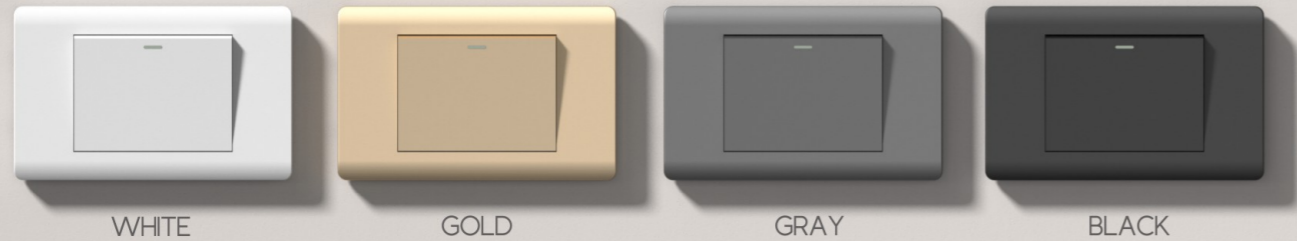

WHITE GOLD GRAY BLACK

A11 BRUSH PC SERIES

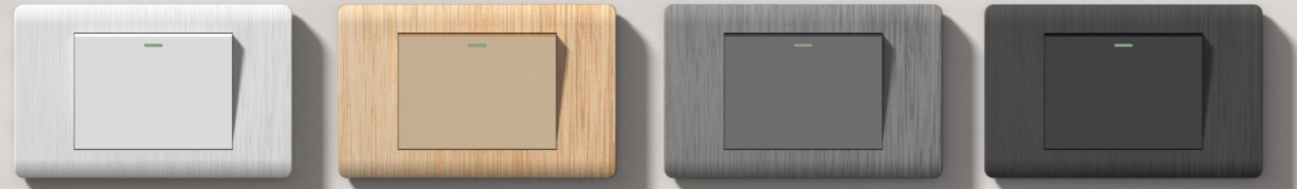

WHITE GOLD GRAY BLACK

A30 CHROME PC SERIES



WHITE GOLD GRAY BLACK

A31 CHROME BRUSH PC SERIES



WHITE GOLD GRAY BLACK

A20 STAINLESS STEEL SERIES



SILVER GOLD GRAY BLACK

A22 ACRYLIC SERIES



WHITE GOLD GRAY BLACK

A40 GLASS SERIES



WHITE GOLD GRAY BLACK

A41 ALUMINIUM SERIES



WHITE GOLD GRAY BLACK

A Series Full Series Showcase

A50 PC SERIES

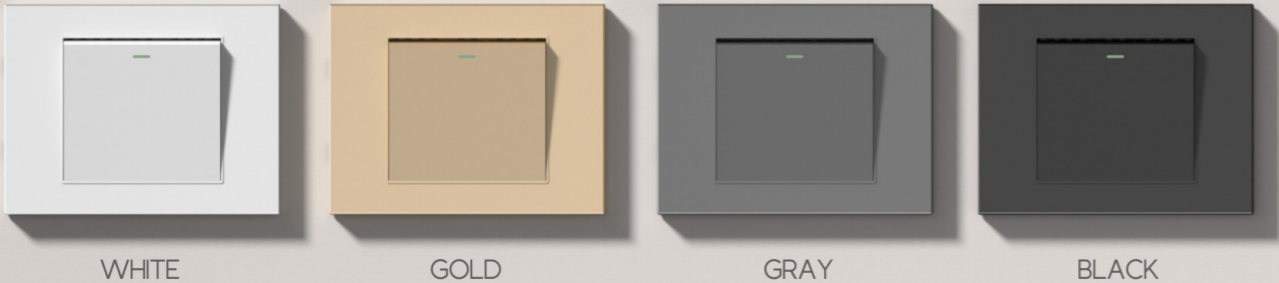

WHITE

GOLD

GRAY

BLACK

A70 CHROME PC SERIES



WHITE

GOLD

GRAY

BLACK

A80 PC SERIES (87×120mm)

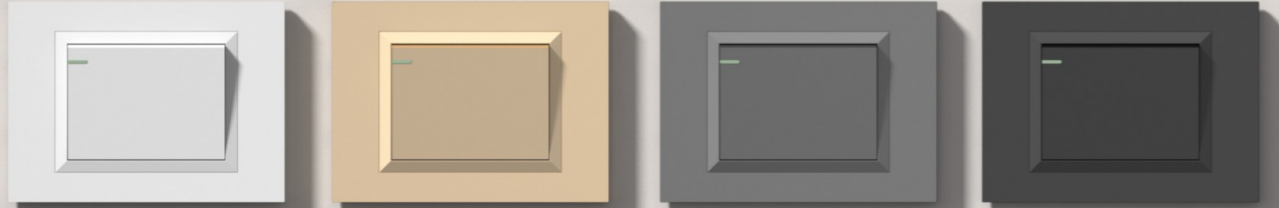

WHITE

GOLD

GRAY

BLACK

A81 ACRYLIC SERIES (87×120mm)



WHITE

GOLD

GRAY

BLACK

A82 STAINLESS STEEL SERIES (87×120mm)

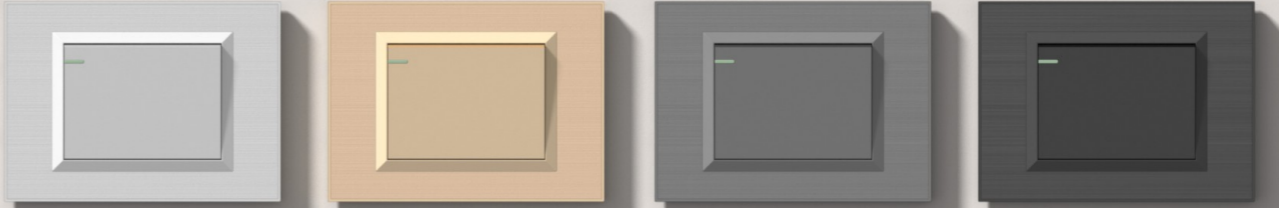

WHITE

GOLD

GRAY

BLACK

A83 PC SERIES (87×120mm)



WHITE

GOLD

GRAY

BLACK

Exploded schematic diagram of switch module

- 01**
High quality PC button
- 02**
High quality PC fire resistant cover
- 03**
New rocker board with fixed bracket structure, performance is more stable, hand feeling is more smooth
- 04**
Ultra-national standard 4mm silver alloy point, 0.35mm thickness
- 05**
New buckle, wiring is more convenient
- 06**
High quality Pc fire resistant backside

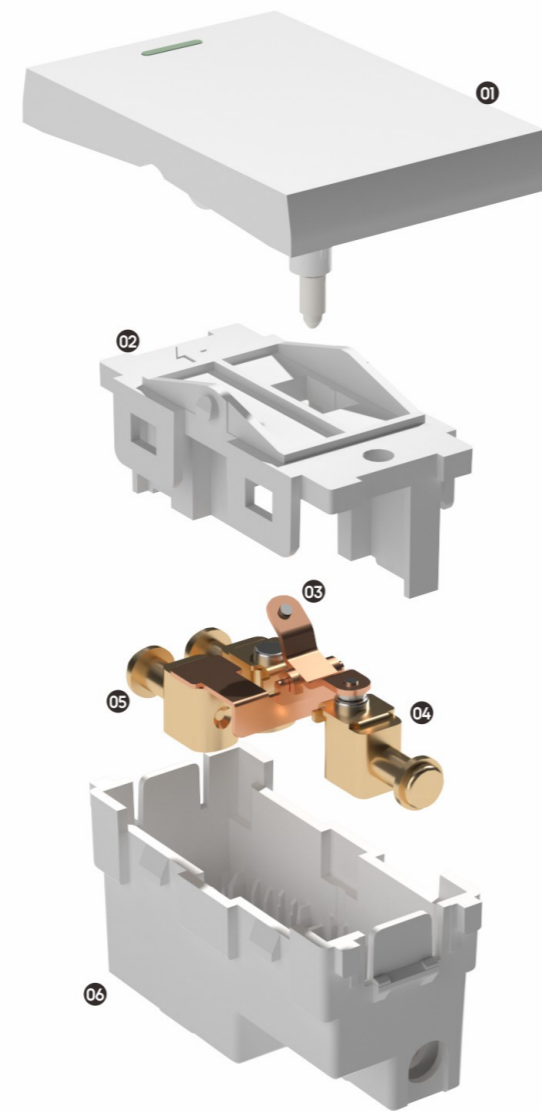

Exploded schematic diagram of two-plug socket module

- 01**
High quality PC frame
- 02**
Fiberglass reinforced PA safety door
Unipolar protection design
- 03**
Fiberglass reinforced PA press plate
- 04**
Widen and thicken. Thickness of copper parts:0.6mm
- 05**
Circlip structure, pull-out force is better
longer lifetime
- 06**
New buckle wiring is more convenient
- 07**
High quality PC fire resistant backside

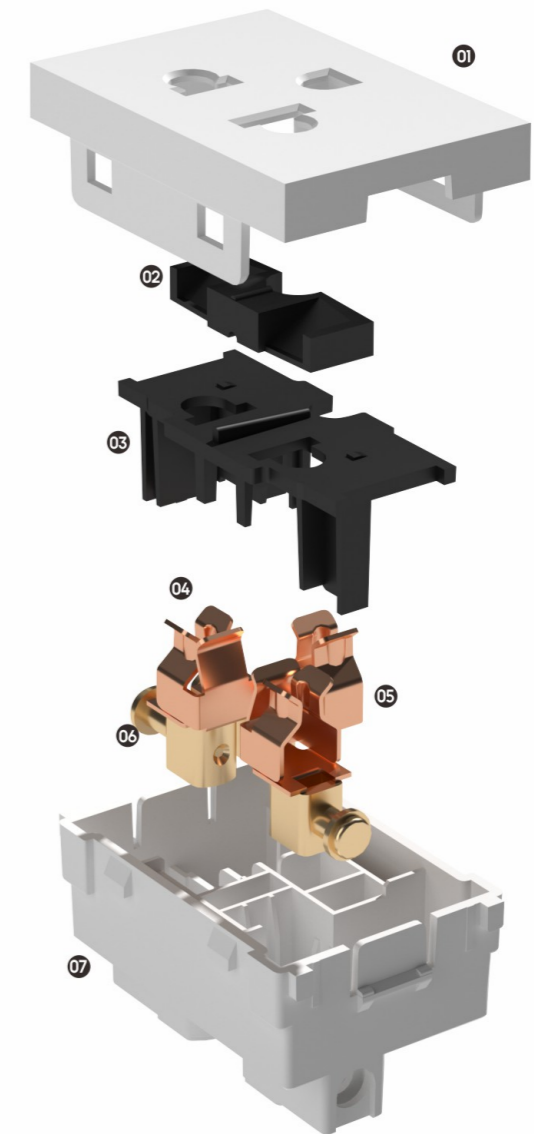

Switch panel specifications show

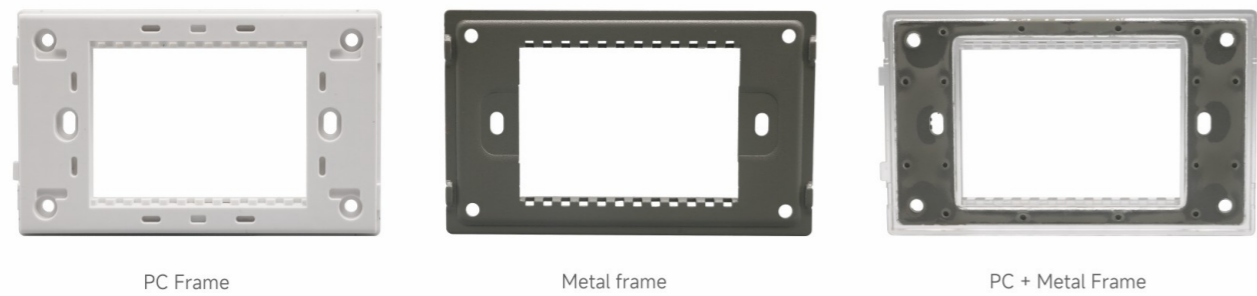

Switching module display

Installation flexibility

The illustration shows how different combination with 1 to 3 modules in the same bracket can be installed

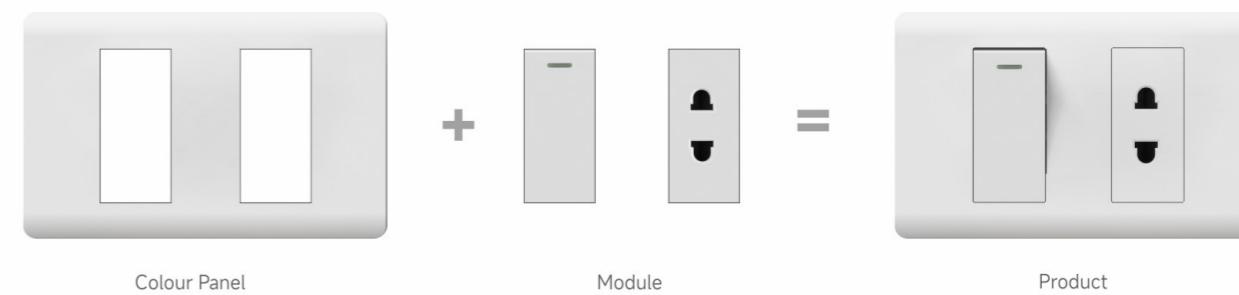



A10 SERIES

HUMAN BODY SENSOR SWITCH

Smart light sensing detects day and night In bright environments, the light does not activate. In dim environments, it activates upon detecting human presence



A10 PC SERIES

Switch And Socket



A11 BRUSH PC SERIES

Switch And Socket

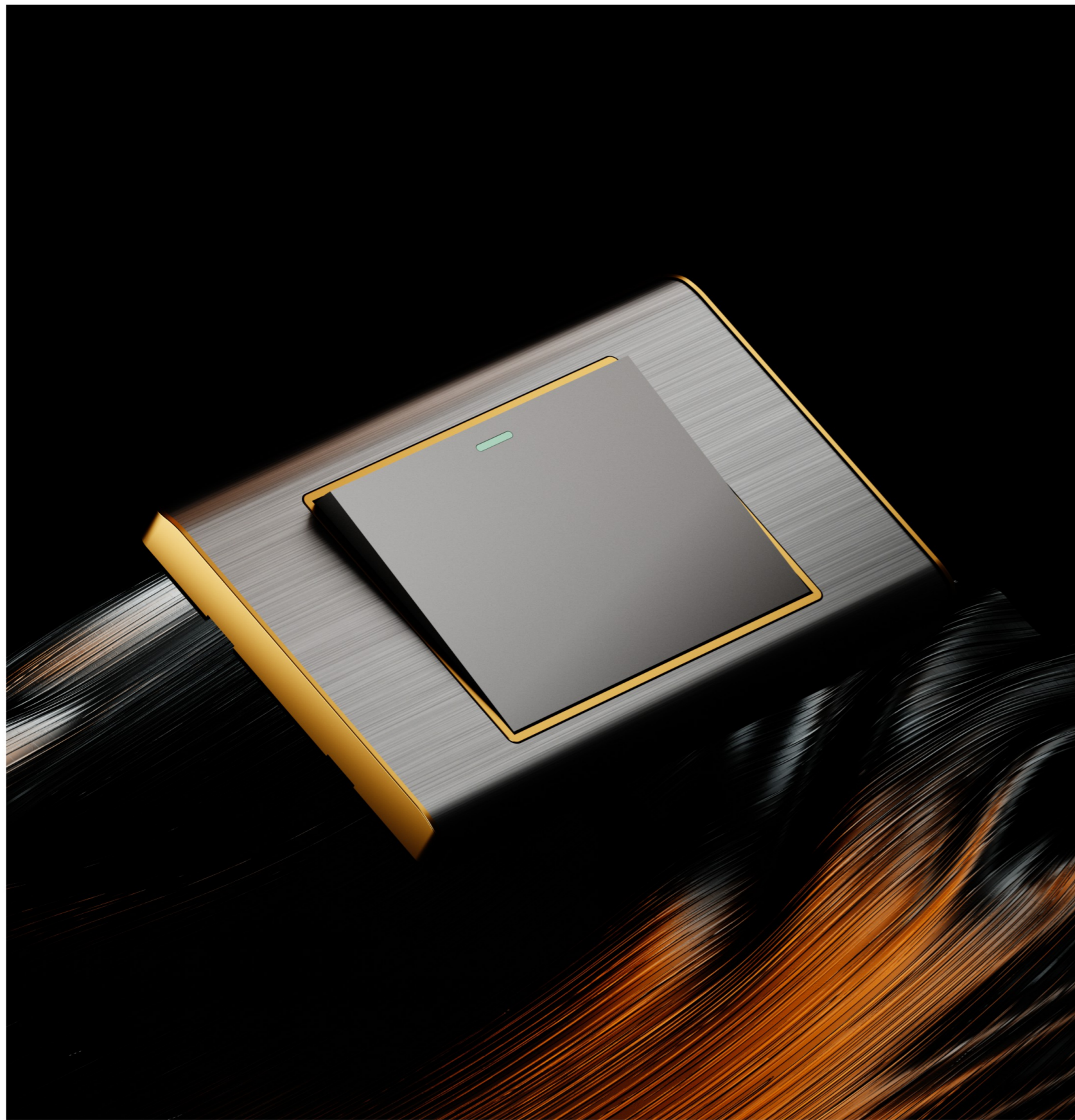

A20 STAINLESS STEEL SERIES

Switch And Socket



A22 ACRYLIC SERIES

Switch And Socket



A30 CHROME PC SERIES

Switch And Socket

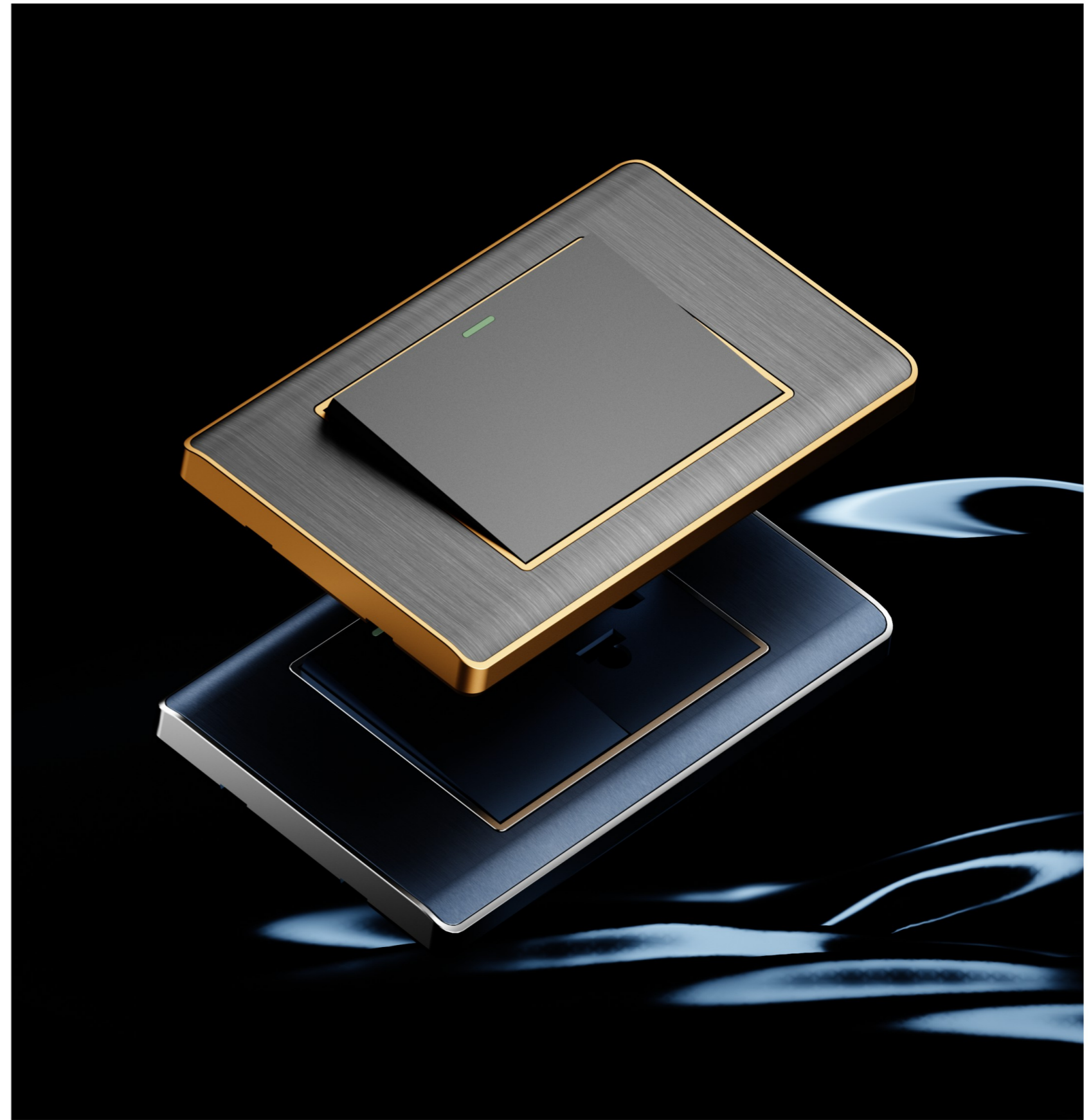

A31 CHROME BRUSH PC SERIES

Switch And Socket

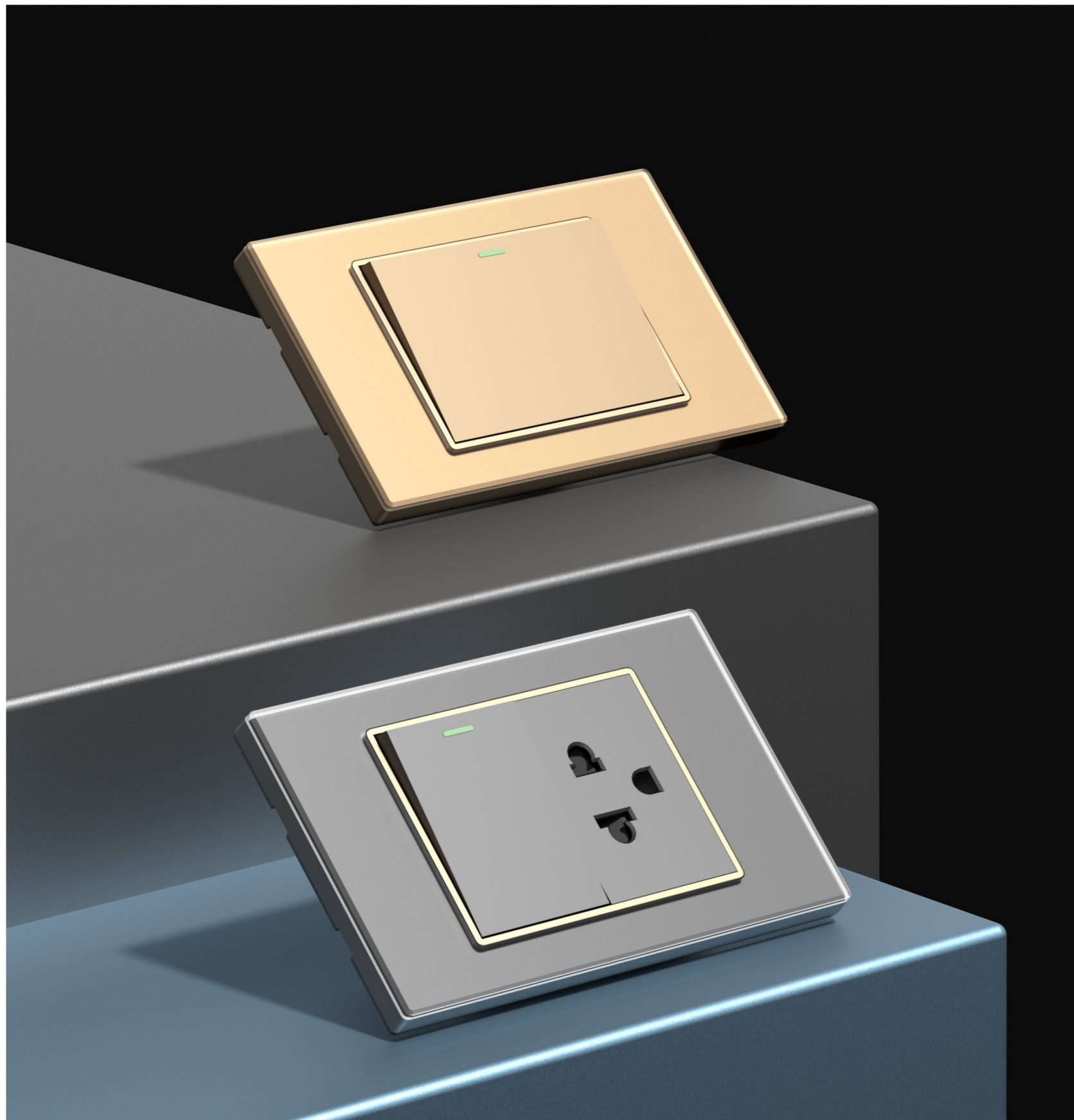

A40 GLASS SERIES

Switch And Socket



A41 ALUMINIUM SERIES

Switch And Socket



A50 PC SERIES

Switch And Socket

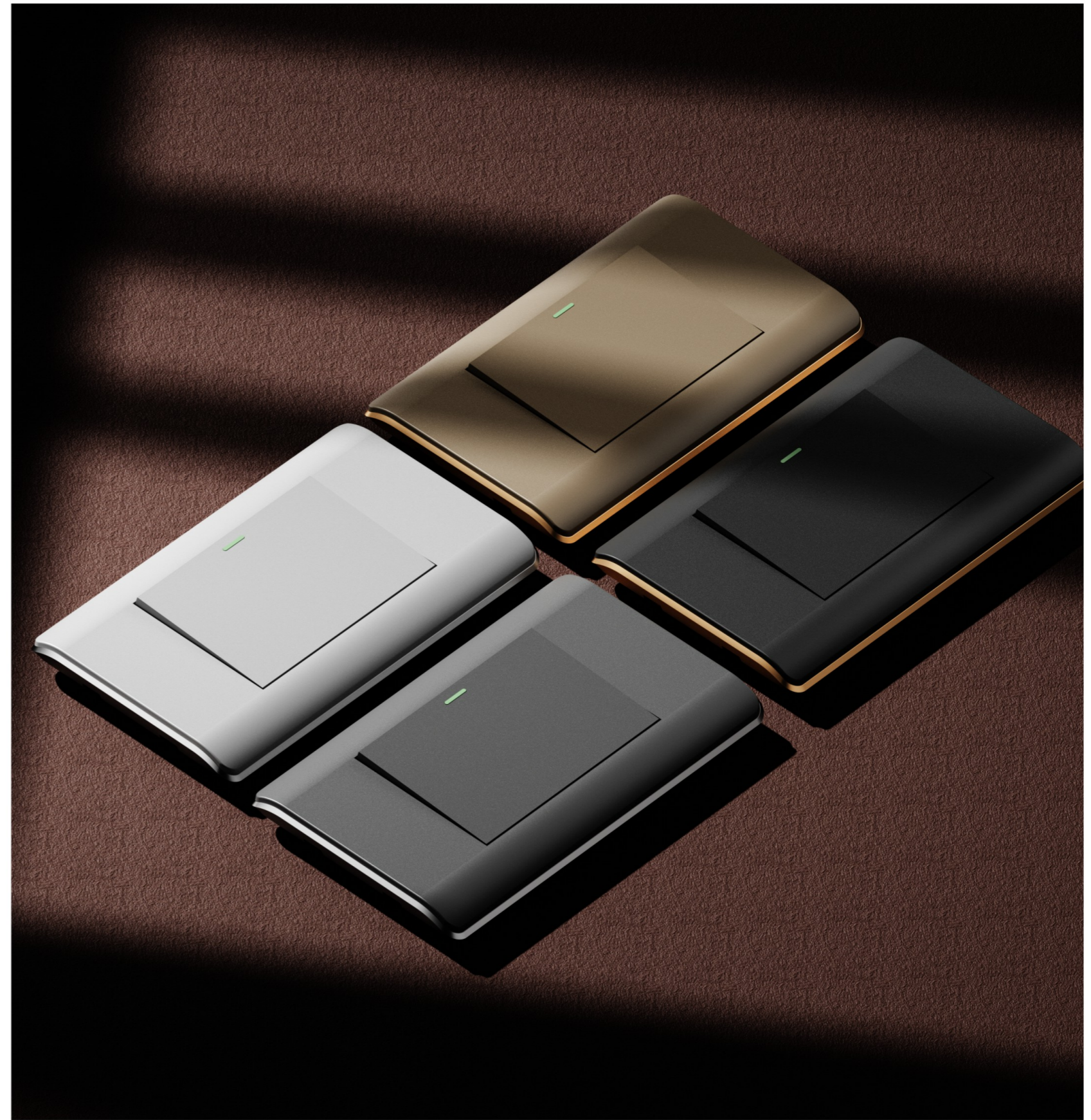

A70 CHROME PC SERIES

Switch And Socket



A80 PC SERIES

Switch And Socket

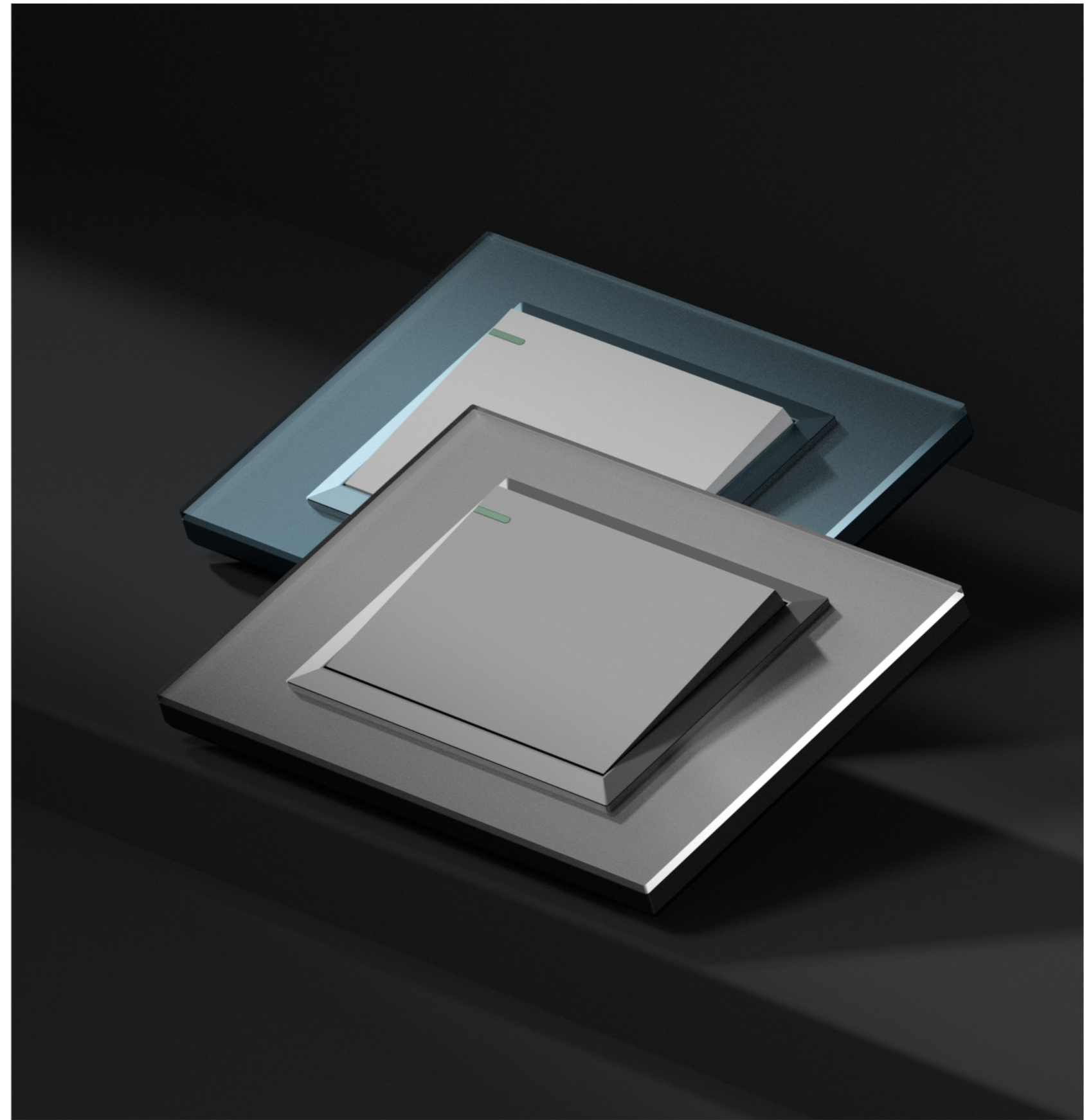

A81 ACRYLIC SERIES

Switch And Socket



A82 STAINLESS STEEL SERIES

Switch And Socket

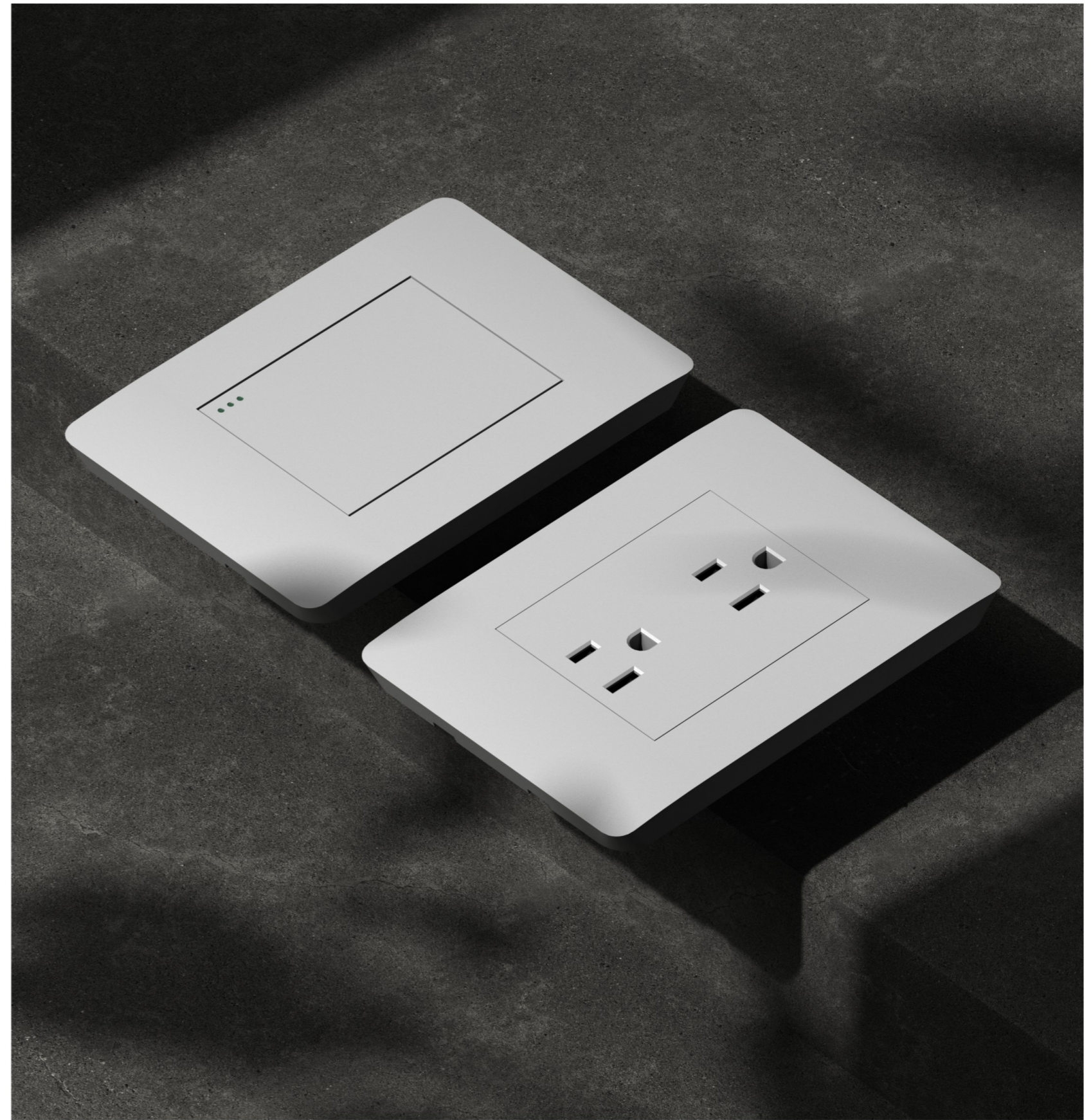

A83 PC SERIES

Switch And Socket

A SERIES

SWITCH PRODUCTS



A10113/123
1 gang 1 way switch (3/3)
1 gang 2 way switch (3/3)



A10111/121
1 gang 1 way switch (1/2)
1 gang 2 way switch (1/2)



A101101/1201/1301
1 gang 1 way switch (1/3)
1 gang 2 way switch (1/3)
1 gang 3 way switch (1/3)



A10213/223
2 gang 1 way switch (3/3)
2 gang 2 way switch (3/3)

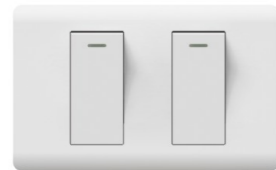

A10212/222
2 gang 1 way switch (1/3)
2 gang 2 way switch (1/3)



A10313/323
3 gang 1 way switch
3 gang 2 way switch



A10413/423
4 gang 1 way switch
4 gang 2 way switch



A10613/623
6 gang 1 way switch
6 gang 2 way switch



A10103
Doorbell switch (3/3)



A10101
Doorbell switch (1/2)



A101001
Doorbell switch (1/3)



A1032A3/453
32A switch (3/3)
45A switch (3/3)



A102001
20A switch (1/3)

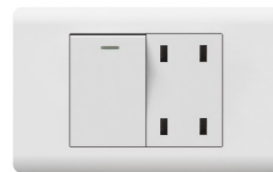

A1011MB43/12MB43
1 gang 1 way switch with Duplex 2P socket
1 gang 2 way switch with Duplex 2P socket

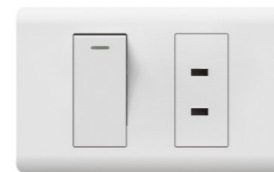

A1011MB22/12MB22
1 gang 1 way switch with 2P socket (1/3)
1 gang 2 way switch with 2P socket (1/3)

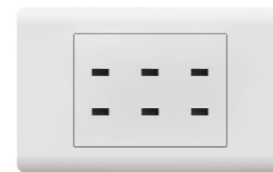

A10MB63
Triple 2P socket

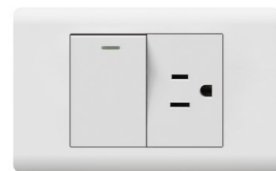

A1011M33/12M33
1 gang 1 way switch with 3P socket (3/3)
1 gang 2 way switch with 3P socket (3/3)

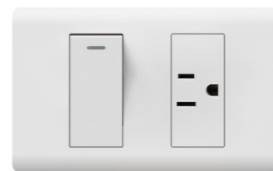

A1011M32/12M32
1 gang 1 way switch with 3P socket (1/3)
1 gang 2 way switch with 3P socket (1/3)



A1021M33/22M33
2 gang 1 way switch with 3P socket
2 gang 2 way switch with 3P socket



A1011M63/12M63
1 gang 1 way switch with 2 gang 3P socket
1 gang 2 way switch with 2 gang 3P socket

A SERIES

SOCKET PRODUCTS

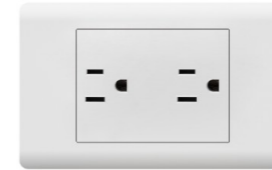

A10M63
Duplex 3P socket

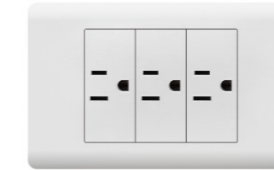

A10M93
3 gang 3P socket



A10M3UC3
3P socket with USB (A+C) (3/3)

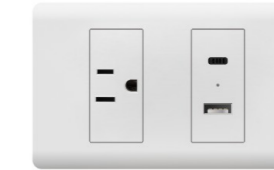

A10M3UC2
3P socket with USB (A+C) (1/3)



A10M3M3UC3
2 gang 3P socket with USB (A+C)

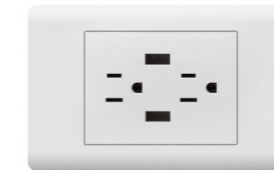

A10M6UA3
Duplex 3P socket with 2USB

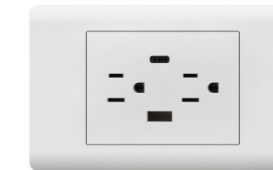

A10M6UC3
Duplex 3P socket with USB (A+C)



A1011T33/12T33
1 gang 1 way switch with 3P socket (3/3)
1 gang 2 way switch with 3P socket (3/3)

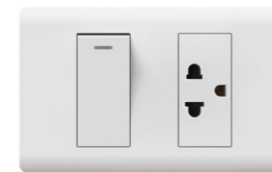

A1011T32/12T32
1 gang 1 way switch with 3P socket (1/3)
1 gang 2 way switch with 3P socket (1/3)



A10T63
Duplex 3P socket

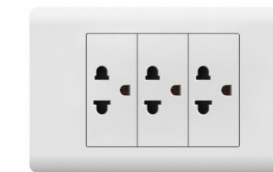

A10T93
3 gang 3P socket

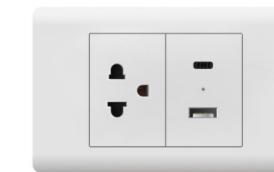

A10T3UC3
3P socket

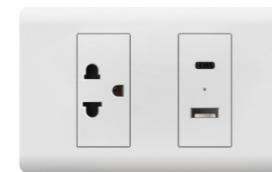

A10T3UC2
3P socket with USB (A+C) (1/3)

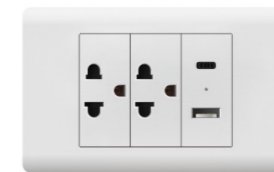

A10T3T3UC3
2 gang 3P socket with USB (A+C)

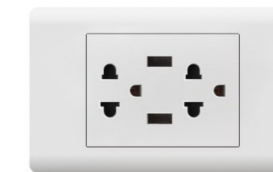

A10T6UA3
Duplex 3P socket with 2USB



A1011BD23/12BD23
1 gang 1 way switch with 2P+E socket (3/3)
1 gang 2 way switch with 2P+E socket (3/3)

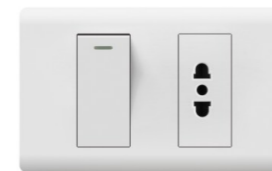

A1011BD22/12BD22
1 gang 1 way switch with 2P+E socket (1/3)
1 gang 2 way switch with 2P+E socket (1/3)

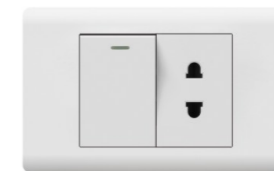

A1011B23/12B23
1 gang 1 way switch with 2P socket (3/3)
1 gang 2 way switch with 2P socket (3/3)

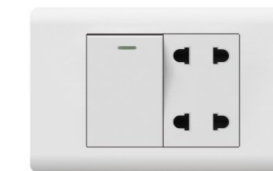

A1011B43/12B43
1 gang 1 way switch with Duplex 2P socket
1 gang 2 way switch with Duplex 2P socket

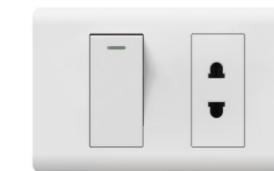

A1011B22/12B22
1 gang 1 way switch with 2P socket (1/3)
1 gang 2 way switch with 2P socket (1/3)

A SERIES

SOCKET PRODUCTS

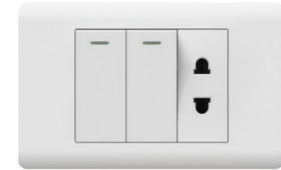

A1021B23/22B23
2 gang 1 way switch with 2P socket (3/3)
2 gang 2 way switch with 2P socket (3/3)

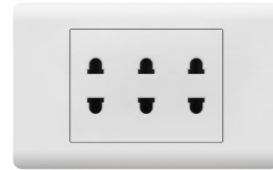

A10B63
Triple 2P socket



A10B2UA2
2P socket with 2USB (1/3)

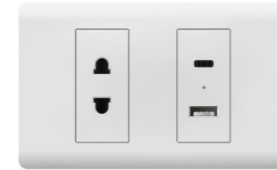

A10B2UC2
2P socket with USB (A+C) (1/3)



A10B2UA3
2P socket with 2 USB (3/3)



A10B2UC3
2P socket with USB (A+C) (3/3)



A10B2D33
2P socket with 3P MF socket (3/3)



A1011D32/3 A1012D32/3
1 gang 1 way switch with 3P MF socket (2/3)
1 gang 2 way switch with 3P MF socket (2/3)

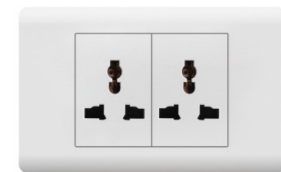

A10D63
2 gang 3P MF socket

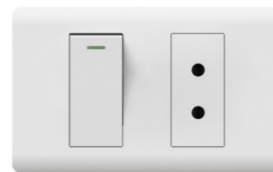

A1011Y22/12Y22
1 gang 1 way switch with 2P socket (1/3)
1 gang 2 way switch with 2P socket (1/3)

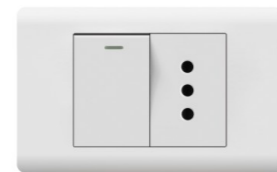

A1011Y33/12Y33
1 gang 1 way switch with 3P socket (3/3)
1 gang 2 way switch with 3P socket (3/3)

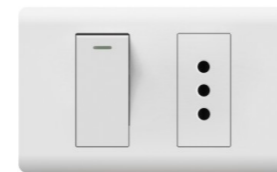

A1011Y32/12Y32
1 gang 1 way switch with 3P socket (1/3)
1 gang 2 way switch with 3P socket (1/3)

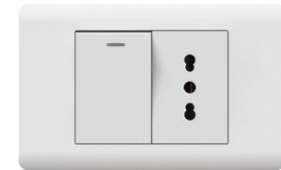

A1011YD33/12YD33
1 gang 1 way switch with 2P+T socket (3/3)
1 gang 2 way switch with 2P+T socket (3/3)

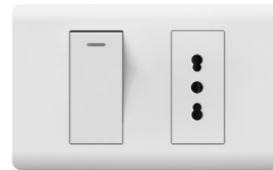

A1011YD32/12YD32
1 gang 1 way switch with 2P+T socket (1/3)
1 gang 2 way switch with 2P+T socket (1/3)



A10YD93
Triple 2P+T socket

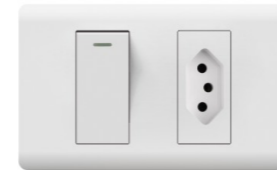

A1011BX2/12BX2
1 gang 1 way switch with 3P socket (1/3)
1 gang 2 way switch with 3P socket (1/3)

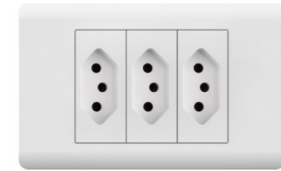

A10BX93
3 gang 3P socket

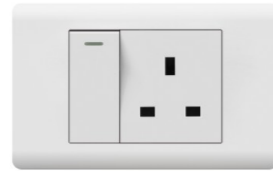

A1011YS2/3 A1012YS2/3
1 gang 1 way switch with 13A socket (2/3)
1 gang 2 way switch with 13A socket (2/3)

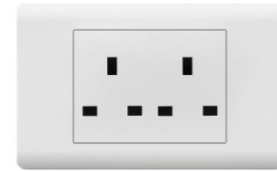

A10YS63
Duplex 13A socket



A1011O22/3 A1012O22/3
1 gang 1 way switch with European socket (2/3)
1 gang 2 way switch with European socket (2/3)

A SERIES

INFORMATION PRODUCTS



A1011TG2/12TG2/11TS2/12TS2
1 gang 1 way switch dimmer light (1/3)
1 gang 2 way switch dimmer light (1/3)
1 gang 1 way switch dimmer fan (1/3)
1 gang 2 way switch dimmer fan (1/3)



A10TG01/TS01
dimmer light switch (1/3)
dimmer fan switch (1/3)



A10DS01
TV socket (1/3)



A10WX01
Satellite socket (1/3)



A10DF01/DN01
TEL socket (1/3)
Computer socket (1/3)



A10DF22/DN22/DFDN2
Double TEL socket (1/3)
Double Computer socket (1/3)
TEL and Computer socket (1/3)



A10DF23/DN23/DFDN3
Double TEL socket (3/3)
Double Computer socket (3/3)
TEL and Computer socket (3/3)



A10WXDF2/WXDN2
Satellite and TEL socket (1/3)
Satellite and Computer socket (1/3)

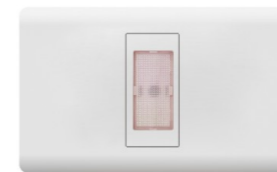

A10ZS01
Indicator (1/3)



A10CL01
Curtain switch (1/3)



A10YP01
3 way loudspeaker (1/3)



A10UA01
2 USB socket (1/3)



A10UA1
2 USB socket (1/2)



A10UC01
USB (A+C) (1/3)



A10UC1
USB (A+C) (1/2)

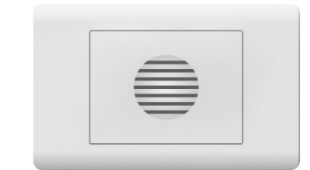

A10FM3
Buzzer switch (3/3)



A10RTH3
Human body sensor switch (3/3)



A10RTS3
Human body sensor switch (3/3)



A101P3/2P3/3P3
1P (3/3)
2P (3/3)
3P (3/3)

A SERIES

module



AM113/3
AM123/3
1 gang 1 way switch (3/3)
1 gang 2 way switch (3/3)



AM111/2
AM121/2
1 gang 1 way switch (1/2)
1 gang 2 way switch (1/2)



AM111/3 **AM121/3**
AM131/3
1 gang 1 way switch (1/3)
1 gang 2 way switch (1/3)
1 gang 3 way switch (1/3)



AM211/2
AM221/2
2 gang 1 way switch (1/2)
2 gang 2 way switch (1/2)



AM211/3
AM221/3
2 gang 1 way switch (1/3)
2 gang 2 way switch (1/3)



AM103/3
Doorbell switch (3/3)



AM101/2
Doorbell switch (1/2)



AM101/3
Doorbell switch (1/3)



AM323/3 **AM453/3**
32A switch (3/3)
45A switch (3/3)



AM201/3
20A switch (1/3)



AMMB21/3
2P socket (1/3)



AMMB21/2
2P socket (1/2)



AMMB41/2
Duplex 2P socket (1/2)



AMMB63/3
Triple 2P socket (3/3)



AMM31/3
3P socket (1/3)



AMM31/2
3P socket (1/2)



AMM63/3
Duplex 3P socket (3/3)



AMM6UA3/3
Duplex 3P socket
with 2USB (3/3)



AMM6UC3/3
Duplex 3P socket
with USB (A+C) (3/3)



AMT31/3
3P socket (1/3)

A SERIES

module



AMT31/2
3P socket (1/2)



AMT63/3
Duplex 3P socket (3/3)



AMT6UA3/3
Duplex socket 3P
with 2USB



AMBD21/3
2P+E socket (1/3)



AMBD21/2
2P +E socket (1/2)



AMB21/3
2P socket (1/3)



AMB21/2
2P socket (1/2)



AMB41/2
Duplex 2P socket (1/2)



AMB63/3
Triple 2P socket (3/3)



AMD31/2
3P MF socket (1/2)



AMD32/3
3P MF socket (2/3)



AMY21/3
2P socket (1/3)



AMY21/2
2P socket (1/2)



AMY31/3
3P socket (1/3)



AMY31/2
3P socket (1/2)



AMYD31/3
2P+T socket (1/3)



AMYD31/2
2P+T socket (1/2)



AMBX1/3
3P socket (1/3)



AMYS1/2
13A socket (1/2)



AMYS2/3
13A socket (2/3)

A SERIES

module



AMYS63/3
Duplex 13A socket (3/3)



AMO22/3
European socket (2/3)



AMDS1/3
TV socket (1/3)



AMDS1/2
TV socket (1/2)



AMWX1/3
Satellite socket (1/3)



AMFM3/3
Buzzer (3/3)



AMKB1/3
Blank (1/3)



AMKB1/2
Blank (1/2)



AMB63/3
Blank (3/3)



AMCL1/3
Curtain switch (1/3)

A SERIES

module



AMWX1/2
Satellite socket (1/2)



**AMDF1/3
AMDN1/3**
TEL socket (1/3)
Computer socket (1/3)



**AMDF1/2
AMDN1/2**
TEL socket (1/2)
Computer socket (1/2)



AMYP1/3
3 way loudspeaker (1/3)



AMZS1/3
Indicator socket (1/3)



AMB2WUC2/3
2P socket with wire
USB (A+C) (2/3)



AMRTH3
Human body sensor
switch (3/3)



AMZS1/2
Indicator socket (1/2)



AMUA1/3
2USB socket (1/3)



AMUA1/2
2USB socket (1/2)



AMUC1/3
USB (A+C)
socket (1/3)



AMUC1/2
USB (A+C)
socket (1/2)



AM1P3/3
1P (3/3)



AM2P3/3
2P (3/3)



AM3P3/3
3P (3/3)



AP86
86 wall plate



AMUC2/3
USB (A+C)
socket (2/3)



**AMTG1/3
AMTS1/3**
Dimmer light (1/3)
Dimmer fan (1/3)



**AMTG1/2
AMTS1/2**
Dimmer light (1/2)
Dimmer fan (1/2)



AMFM1/3
Buzzer (1/3)



AMFM1/2
Buzzer (1/2)



AP01
1 gang wall plate (1/3)



AP1
1 gang wall plate (1/2)



AP2
2 gang wall plate (1/3)



AP3
3 gang wall plate (3/3)

C SERIES SWITCH SOCKET PRODUCTS

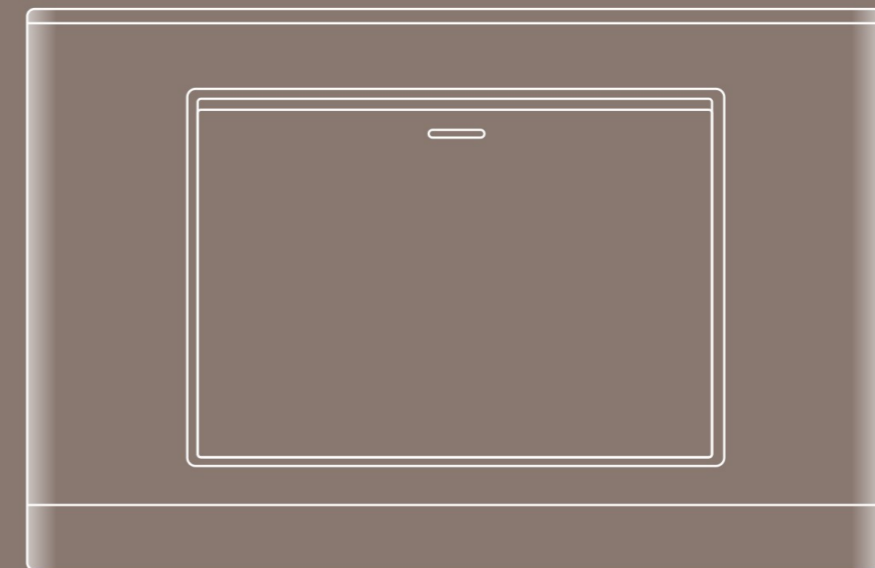

C Series Full Series Showcase

C11 PC SERIES

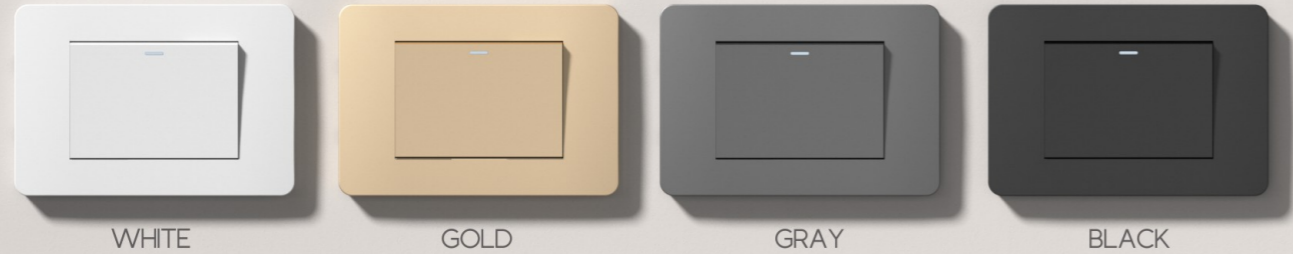

WHITE

GOLD

GRAY

BLACK

C12 PC SERIES

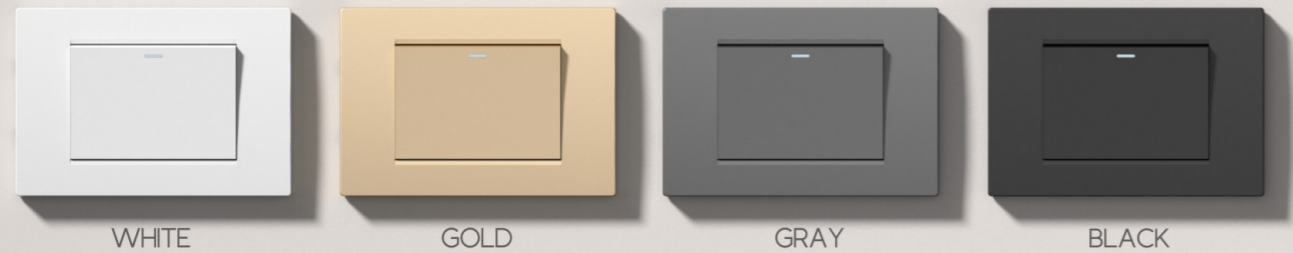

WHITE

GOLD

GRAY

BLACK

C21 CHROME PC SERIES

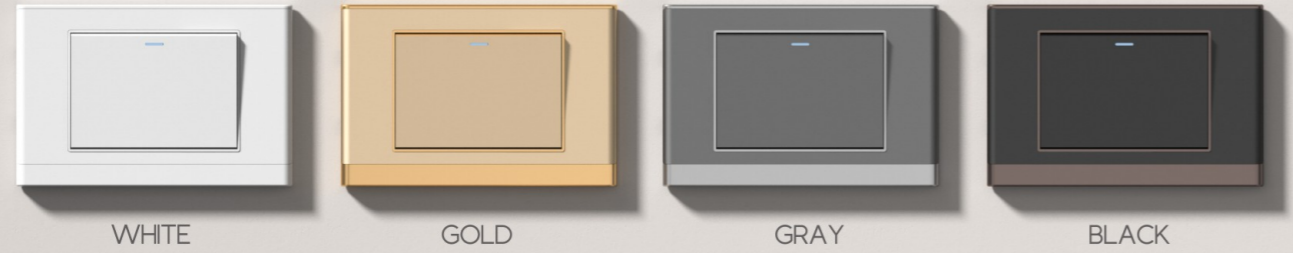

WHITE

GOLD

GRAY

BLACK

C21 STAINLESS STEEL SERIES



SILVER

GOLD

GRAY

BLACK

C22 ACRYLIC SERIES



WHITE

GOLD

GRAY

BLACK

C22 STAINLESS STEEL SERIES



SILVER

GOLD

GRAY

BLACK

C31 STAINLESS STEEL SERIES

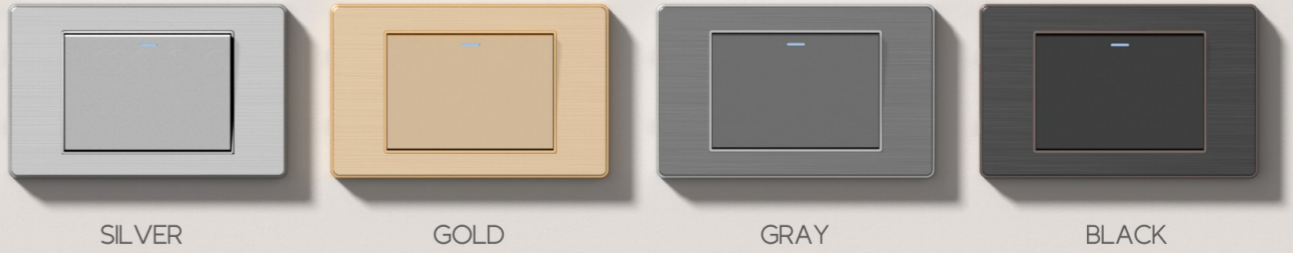

SILVER

GOLD

GRAY

BLACK



C11 SERIES
Switch And Socket



C12 SERIES
Switch And Socket

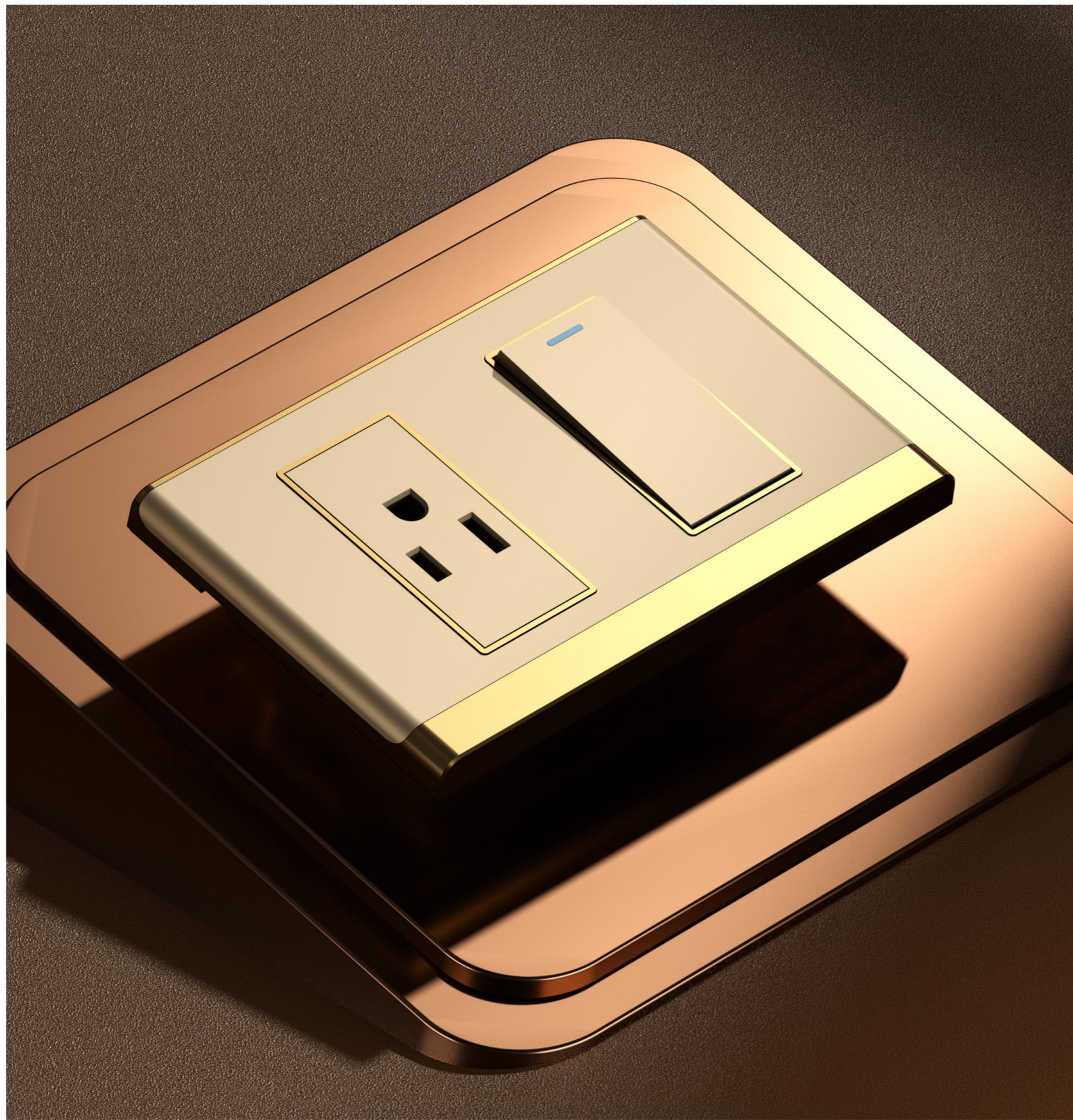

C21 CHROME PC SERIES

Switch And Socket



C21 STAINLESS STEEL SERIES

Switch And Socket



C22 ACRYLIC SERIES

Switch And Socket



C22 STAINLESS STEEL SERIES

Switch And Socket

C31 STAINLESS STEEL SERIES



APPRECIATING MINIMALIST DESIGN

The switches are complete illustrations of the art of light control. With a wide range of colours, materials and designs, minimalist styles and elegant, responsive panels, the extensive product portfolio is sure to have one is right for you.

C SERIES

SWITCH PRODUCTS



C1113/123
1 gang 1 way switch (3/3)
1 gang 2 way switch (3/3)



C1111/121
1 gang 1 way switch (1/2)
1 gang 2 way switch (1/2)



C11101/1201/1301
1 gang 1 way switch (1/3)
1 gang 2 way switch (1/3)
1 gang 3 way switch (1/3)



C1213/223
2 gang 1 way switch (3/3)
2 gang 2 way switch (3/3)



C1212/222
2 gang 1 way switch (1/3)
2 gang 2 way switch (1/3)

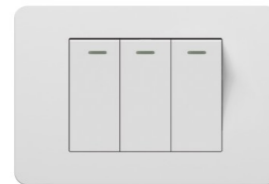

C1313/323
3 gang 1 way switch
3 gang 2 way switch



C1413/423
4 gang 1 way switch
4 gang 2 way switch



C1613/623
6 gang 1 way switch
6 gang 2 way switch

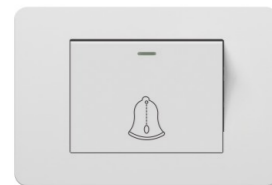

C1103
Doorbell switch (3/3)



C1101
Doorbell switch (1/2)



C11001
Doorbell switch (1/3)



C132A3/453
32A switch (3/3)
45A switch (3/3)



C12001
20A switch (1/3)

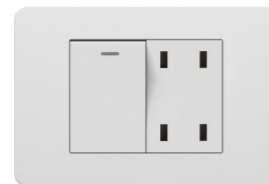

C111MB43/12MB43
1 gang 1 way switch
with Duplex 2P socket
1 gang 2 way switch
with Duplex 2P socket

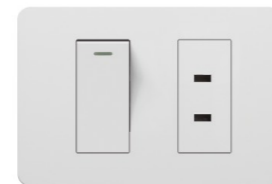

C111MB22/12MB22
1 gang 1 way switch
with 2P socket (1/3)
1 gang 2 way switch
with 2P socket (1/3)

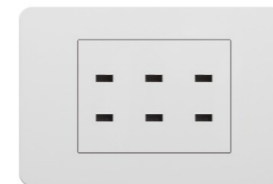

C1MB63
Triple 2P socket

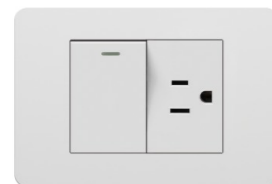

C111M33/12M33
1 gang 1 way switch
with 3P socket (3/3)
1 gang 2 way switch
with 3P socket (3/3)

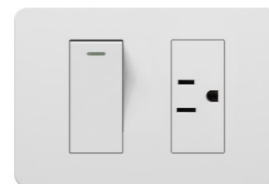

C111M32/12M32
1 gang 1 way switch with
3P socket (1/3)
1 gang 2 way switch with
3P socket (1/3)

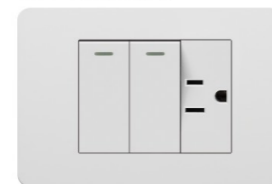

C121M33/22M33
2 gang 1 way switch with
3P socket
2 gang 2 way switch with
3P socket

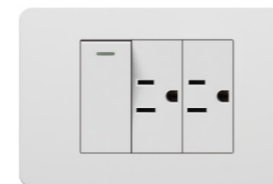

C111M63/12M63
1 gang 1 way switch with 2 gang
3P socket
1 gang 2 way switch with 2 gang
3P socket

C SERIES

SOCKET PRODUCTS



C1M63
Duplex 3P socket

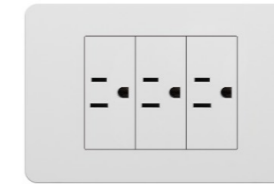

C1M93
3 gang 3P socket

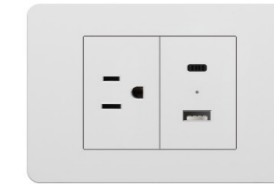

C1M3UC3
3P socket
with USB (A+C) (3/3)

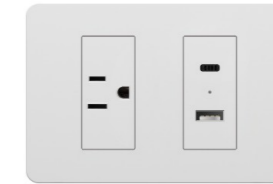

C1M3UC2
3P socket
with USB (A+C) (1/3)

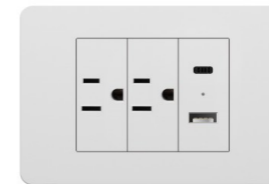

C1M3M3UC3
2 gang 3P socket
with USB (A+C)

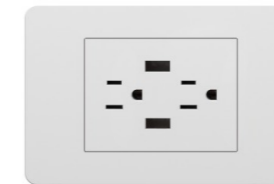

C1M6UA3
Duplex 3P socket
with 2USB

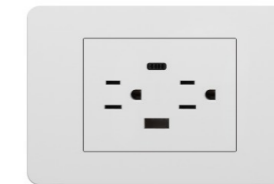

C1M6UC3
Duplex 3P socket
with USB (A+C)

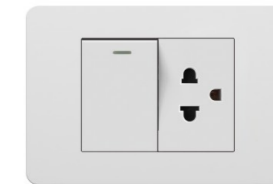

C111T33/12T33
1 gang 1 way switch
with 3P socket (3/3)
1 gang 2 way switch
with 3P socket (3/3)

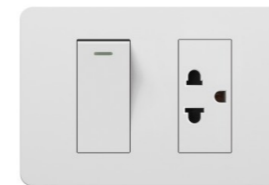

C111T32/12T32
1 gang 1 way switch
with 3P socket (1/3)
1 gang 2 way switch
with 3P socket (1/3)



C1T63
Duplex 3P socket

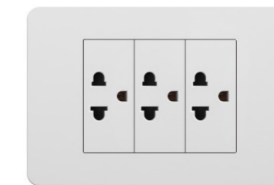

C1T93
3 gang 3P socket

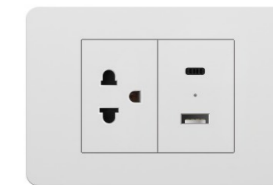

C1T3UC3
3P socket

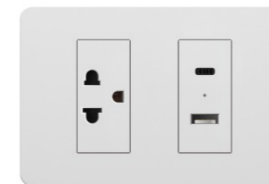

C1T3UC2
3P socket
with USB (A+C) (1/3)

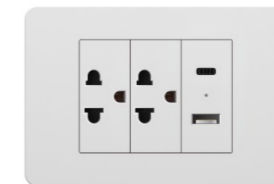

C1T3T3UC3
2 gang 3P socket
with USB (A+C)

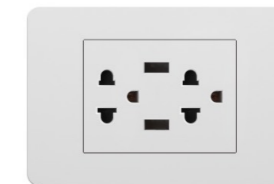

C1T6UA3
Duplex 3P socket
with 2USB

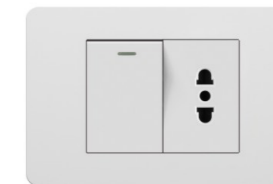

C111BD23/12BD23
1 gang 1 way switch
with 2P+E socket (3/3)
1 gang 2 way switch
with 2P+E socket (3/3)



C111BD22/12BD22
1 gang 1 way switch
with 2P+E socket (1/3)
1 gang 2 way switch
with 2P+E socket (1/3)

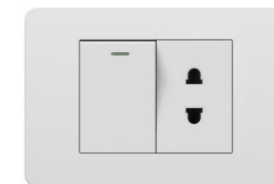

C111B23/12B23
1 gang 1 way switch
with 2P socket (3/3)
1 gang 2 way switch
with 2P socket (3/3)

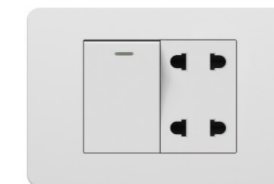

C111B43/12B43
1 gang 1 way switch
with Duplex 2P socket
1 gang 2 way switch
with Duplex 2P socket

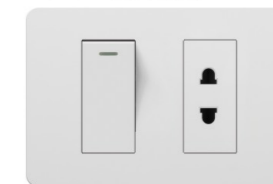

C111B22/12B22
1 gang 1 way switch
with 2P socket (1/3)
1 gang 2 way switch
with 2P socket (1/3)

C SERIES

SOCKET PRODUCTS



C121B23/22B23
2 gang 1 way switch with 2P socket (3/3)
2 gang 2 way switch with 2P socket (3/3)



C1B63
Triple 2P socket



C1B2UA2
2P socket with 2USB (1/3)

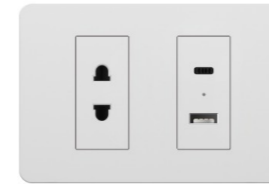

C1B2UC2
2P socket with USB (A+C) (1/3)



C1B2UA3
2P socket with 2 USB (3/3)



C1B2UC3
2P socket with USB (A+C) (3/3)



C1B2D33
2P socket with 3P MF socket (3/3)

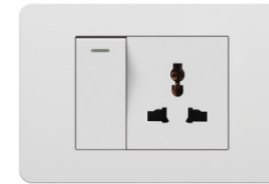

C111D32/3 C112D32/3
1 gang 1 way switch with 3P MF socket (2/3)
1 gang 2 way switch with 3P MF socket (2/3)



C1D63
2 gang 3P MF socket

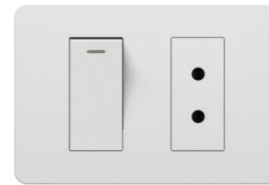

C111Y22/12Y22
1 gang 1 way switch with 2P socket (1/3)
1 gang 2 way switch with 2P socket (1/3)

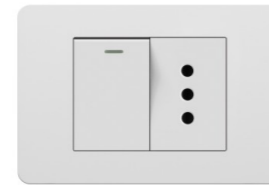

C111Y33/12Y33
1 gang 1 way switch with 3P socket (3/3)
1 gang 2 way switch with 3P socket (3/3)

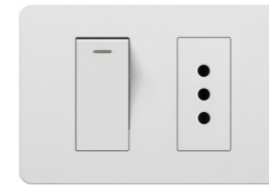

C111Y32/12Y32
1 gang 1 way switch with 3P socket (1/3)
1 gang 2 way switch with 3P socket (1/3)

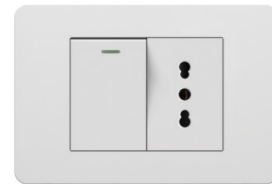

C111YD33/12YD33
1 gang 1 way switch with 2P+T socket (3/3)
1 gang 2 way switch with 2P+T socket (3/3)

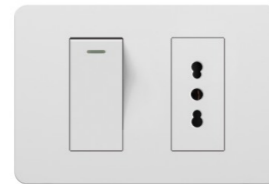

C111YD32/12YD32
1 gang 1 way switch with 2P+T socket (1/3)
1 gang 2 way switch with 2P+T socket (1/3)

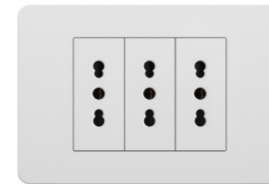

C1YD93
Triple 2P+T socket

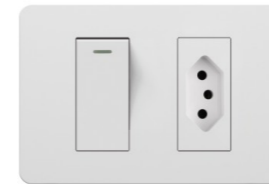

C111BX2/12BX2
1 gang 1 way switch with 3P socket (1/3)
1 gang 2 way switch with 3P socket (1/3)

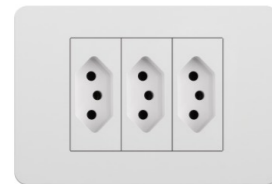

C1BX93
3 gang 3P socket

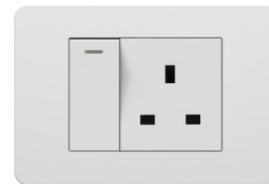

C111YS2/3 C112YS2/3
1 gang 1 way switch with 13A socket (2/3)
1 gang 2 way switch with 13A socket (2/3)

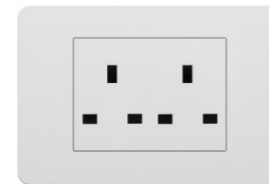

C1YS63
Duplex 13A socket



C111O22/3 C112O22/3
1 gang 1 way switch with European socket (2/3)
1 gang 2 way switch with European socket (2/3)

C SERIES

INFORMATION PRODUCTS



C111TG2/12TG2/11TS2/12TS2
1 gang 1 way switch dimmer light (1/3)
1 gang 2 way switch dimmer light (1/3)
1 gang 1 way switch dimmer fan (1/3)
1 gang 2 way switch dimmer fan (1/3)



C1TG01/TS01
dimmer light switch (1/3)
dimmer fan switch (1/3)

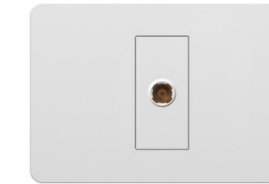

C1DS01
TV socket (1/3)

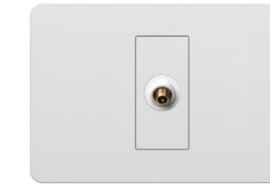

C1WX01
Satellite socket (1/3)

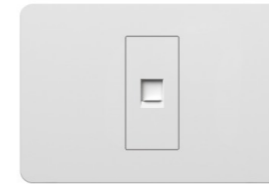

C1DF01/DN01
TEL socket (1/3)
Computer socket (1/3)



C1DF22/DN22/DFDN2
Double TEL socket (1/3)
Double Computer socket (1/3)
TEL and Computer socket (1/3)



C1DF23/DN23/DFDN3
Double TEL socket (3/3)
Double Computer socket (3/3)
TEL and Computer socket (3/3)

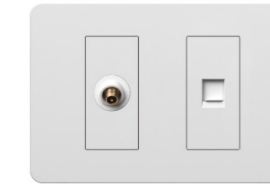

C1WXDF2/WXDN2
Satellite and TEL socket (1/3)
Satellite and Computer socket (1/3)

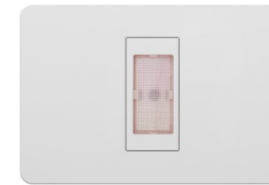

C1ZS01
Indicator (1/3)



C1CL01
Curtain switch (1/3)

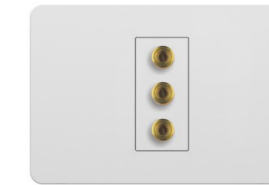

C1YP01
3 way loudspeaker (1/3)



C1UA01
2 USB socket (1/3)



C1UA1
2 USB socket (1/2)



C1UC01
USB (A+C) (1/3)



C1UC1
USB (A+C) (1/2)

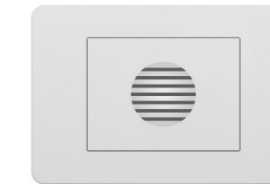

C1FM3
Buzzer switch (3/3)



C11P3/2P3/3P3
1P (3/3)
2P (3/3)
3P (3/3)

J SERIES SWITCH SOCKET PRODUCTS

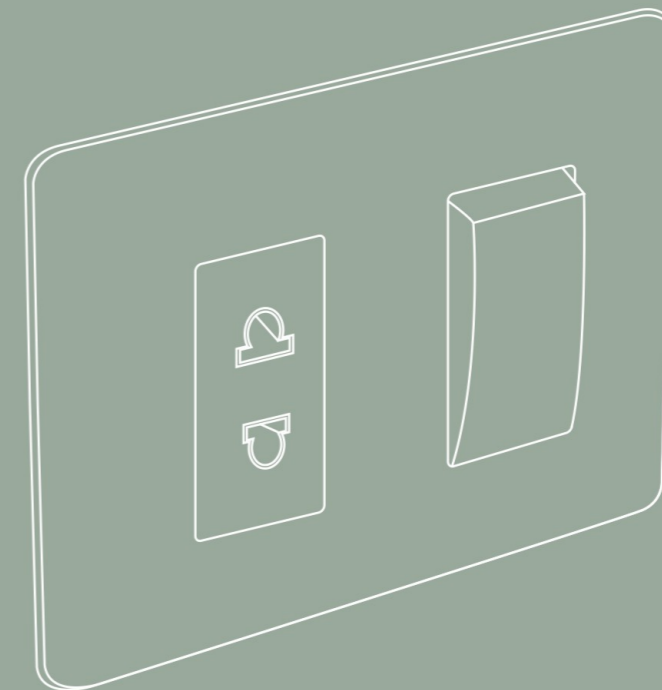

J SERIES

**New design,
new touch**

The art of dissolving in practical, thoughtful design.
The rich variety, pleasing appearance, fine quality, and reliable performance.
to savour life and exemplify with confidence and imagination.



J SERIES

SWITCH PRODUCTS



J1101/1201
1 gang 1 way switch
1 gang 2 way switch

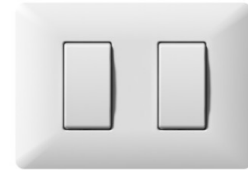

J212/222
2 gang 1 way switch
2 gang 2 way switch

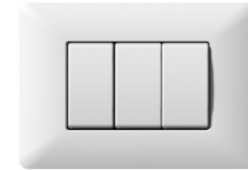

J313/323
3 gang 1 way switch
3 gang 2 way switch



J1001
Doorbell switch



JM3UA3
3P Socket + 2USB

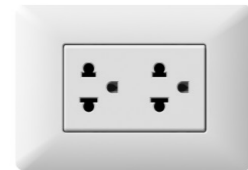

JT63
Duplex socket 2P+T



JT3UA3
Socket 2P+T + 2USB



JB201
2P socket

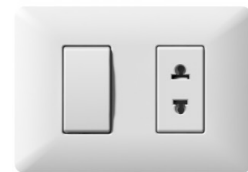

J11B22/J12B22
1 gang 1 way switch
with 2P socket
1 gang 2 way switch
with 2P socket



JB63
Triple 2P socket



JB2UA2
2P socket+2 USB socket



JB2B2UA3
Double 2P socket+2 USB socket



JB2UUA3
Double 2 USB socket+
2P socket

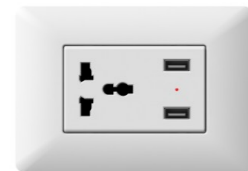

JD3UA3
3P MF socket + 2USB



JWX01
Satellite socket



JDF01/DN01
TEL socket
Computer socket



JWXDH2/WXDN2
Satellite socket and
TEL socket
Satellite socket and
Computer socket



JTG01/TS01
Dimmer Light
Dimmer Fan



JUA01
2 USB socket



JUAUA2
Double 2 USB socket

J SERIES

module



JM111/3
JM121/3
1 gang 1 way switch
1 gang 2 way switch



JM101/3
Doorbell
swtich



JMM3UA3/3
3P Socket + 2USB



JMT63/3
Duplex socket 2P+T



JMT3UA3/3
Socket 2P+T + 2USB



JMB21/3
2P socket



JMB63/3
Triple 2P socket

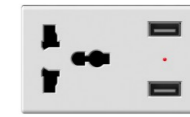

JD3UA3/3
3P MF socket + 2USB



JWX1/3
Satellite socket



JDH1/3
JDN1/3
TEL socket
Computer socket



JTG1/3
TS1/3
dimmer light
dimmer fan



JMUA1/3
2USB socket



JP01
1 gang wall plate



JP2
2 gang wall plate



JP3
3 gang wall plate

D&Z SERIES SWITCH SOCKET PRODUCTS

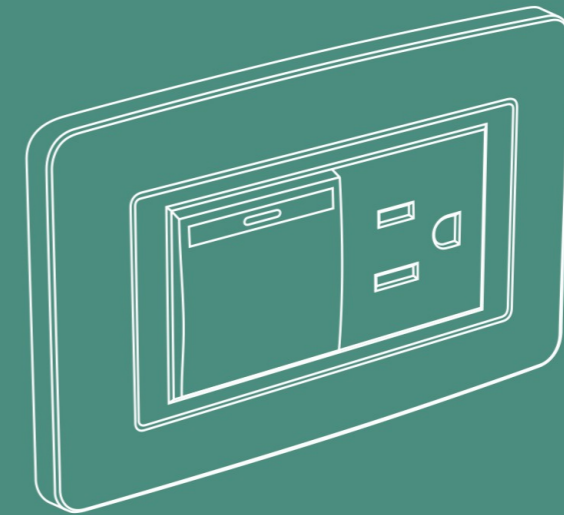
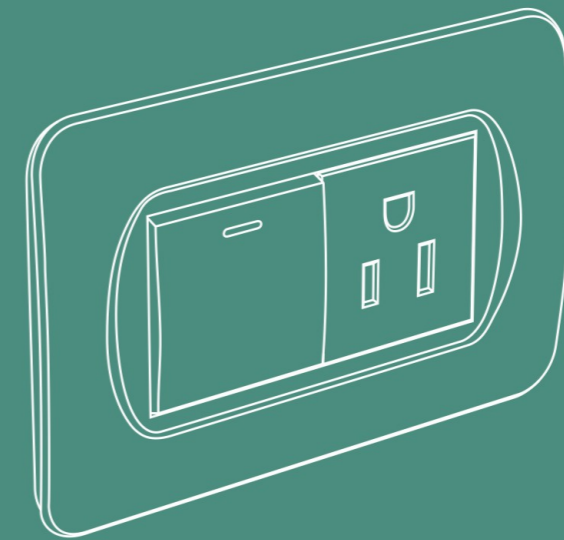



D SERIES
Switch And Socket



D-2 SERIES
Switch And Socket

Z SERIES

APPRECIATING MINIMALIST DESIGN

The switches are complete illustrations of the art of light control. With a wide range of colours, materials and designs, minimalist styles and elegant, responsive panels, the extensive product portfolio is sure to have one is right for you.



Z SERIES

SWITCH PRODUCTS



Z111/121
1 gang 1 way switch
1 gang 2 way switch



Z213/223
2 gang 1 way switch
2 gang 2 way switch



Z313/323
3 gang 1 way switch
3 gang 2 way switch



Z101
Doorbell switch



Z11M33
1 gang 1 way switch with
3P socket



Z12M33
1 gang 2 way switch with
3P socket



ZM63
Duplex 3P socket



ZM3UA3
3P Socket+ 2USB



ZWX1
Satellite socket



ZDF1/DN1
TEL socket
Computer socket



ZDFDF3
Double TEL socket



ZDNDN3
Double Computer socket



ZDFDN3
TEL and Computer socket



ZWXDF3
Satellite and TEL socket



ZWXDN3
Satellite and computer socket



ZUA1
2 USB socket



ZTG1
Light dimmer switch



ZTS1
Fan speed switch



ZKB3
Blank panel

Z SERIES

module



ZM111/2
ZM121/2
1 gang 1 way switch
1 gang 2 way switch



ZM313/3
ZM323/3
3 gang 1 way switch
3 gang 2 way switch



ZM101/2
Doorbell
switch



ZMM31/2
3P socket



ZMM63/3
Duplex 3P socket



ZMWX1/2
Satellite socket

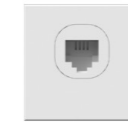

ZMDN1/2
Computer
socket



ZMDF1/2
TEL socket

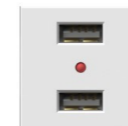

ZMUA1/2
2USB socket



ZMTG1/2
ZMTS1/2
Fan speed
Light dimmer



ZMKB3/3
Blank panel



ZP1
1 gang wall plate



ZP3
3 gang wall plate

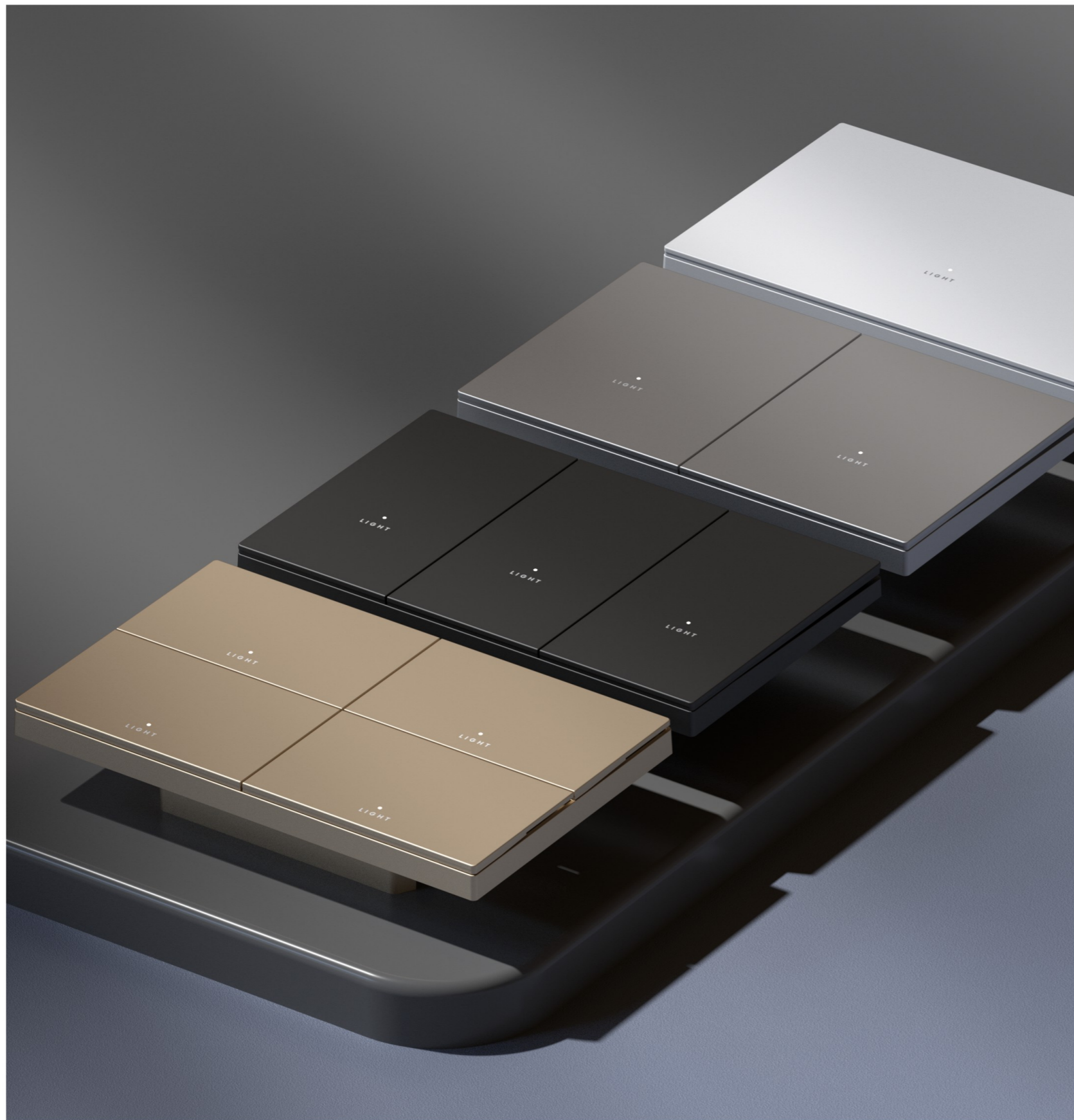

SMART SWITCH

More aesthetic, more elegant, more function, enables you to fully express your creativity and style. Symbol of lightness, thin and sleek, the new range is a breath of fresh air.



PC Products



1 gang smart switch



2 gang smart switch



3 gang smart switch



4 gang smart switch

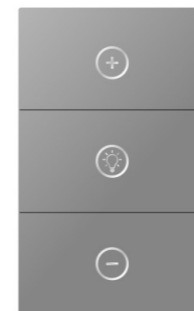

smart light dimmer

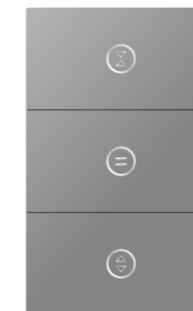

smart Curtain switch



Duplex 3P socket



3P socket + USB Type-c



Duplex 3P socket



3P socket + USB Type-c

Specifications:

Size: 120*74*37mm

Material: Tempered Glass+Flame retardant PC

Color: ● ● ● ●

Max Loading: 600W/Gang (INC200W/Gang (LED))

Voltage Range: AC100-240V 50/60Hz

Wireless Frequency: 2.412-2.484GHz

Communication Protocol: Wi-Fi/Zigbee



SMART SWITCH

More aesthetic, more elegant, more function, enables you to fully express your creativity and style. Symbol of lightness, thin and sleek, the new range is a breath of fresh air.



Glass Button Products



1 gang smart switch



2 gang smart switch



3 gang smart switch



4 gang smart switch



smart Curtain switch



Duplex 3P socket



3P socket + USB Tepy-c



Duplex 3P socket



3P socket + USB Tepy-c

Specifications:

Size:120*74*37mm

Material: Tempered Glass+Flame retardane PC

Color: ● ● ● ●

Max Loading: 600W/Gang (INC200W/Gang (LED)

Voltage Range: AC100-240V 50/60Hz

Wireless Frequency: 2.412~2.484GHz

Communication Protocol: Wi-Fi/Zigbee



Glass Touch Products



1 gang smart switch



2 gang smart switch



3 gang smart switch



4 gang smart switch



smart light dimmer



smart Curtain switch



Duplex 3P socket



3P socket + USB Type-C



Duplex 3P socket



3P socket + USB Type-C

Specifications:

- Size: 120*74*37mm
- Material: Tempered Glass+Flame retardant PC
- Color: ● ● ● ●
- Max Loading: 600W/Gang (100W/Gang (LED))
- Voltage Range: AC100-240V 50/60Hz
- Wireless Frequency: 2.412~2.484GHz
- Communication Protocol: Wi-Fi/Zigbee

SMART SWITCH

More aesthetic, more elegant, more function, enables you to fully express your creativity and style. Symbol of lightness, thin and sleek, the new range is a breath of fresh air.

