

 Printed on Recycled Paper

 All rights reserved by
ZHEJIANG GENO ELECTRICAL CO.,LTD



PRIME COLLECTION

DELIVER SAFETY TO THE WORLD

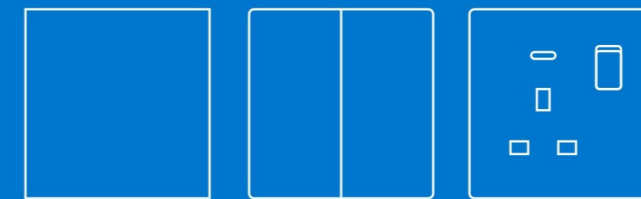

R / KSERIES
switch socket

ZHEJIANG GENO ELECTRICAL CO., LTD.

Add:
No.519, 15th Road, Binhai Industrial Area,
Wenzhou, Zhejiang Province, China

Email: info@china-gog.com

www.gog-elec.com



GOG electrical

ZHEJIANG GENO ELECTRICAL CO., LTD, founded in 2010, is a national high-tech enterprise focusing on household appliances and aesthetic lighting, integrating R&D, manufacturing, trade, service and other functions. The registered capital of the company is 106 million yuan, the plant construction area is more than 100,000 square meters, and more than 2,000 employees.

Main products: switch socket, lamps and lighting, Integrated bath heater, intelligent switch panel, hospital and hotel intelligent, **electrical accessories and other 50 series of more than 1000 varieties of products**, the annual sales of more than 500 million sets, products sold in more than 30 countries and regions around the world.

With a nationwide layout and coordinated development, Geno owns three major automation industry production bases, Wenzhou Electrical production base, Zhongshan Lighting production base and Jiaxing Integrated bath heater production base. It has many subsidiaries including **Geno Electrician, Geno Lighting, Geno Household, Geno Plastic, Geno Alloy, Geno IOT and so on.**



HONOR

Partial



International specialized and special new small giant enterprise
National high-tech enterprises
Zhejiang manufacture "quality" word certification
High performance smart electrical switch Research Institute
Postdoctoral workstation
Scientific and technological innovation enterprise
President Company of Longwan Electrical Appliance Association

QUALIFICATION

Partial



China Green Product Certification
International laboratory accreditation Certificate - CNAS certification
China two integration management system evaluation certificate
ISO 90012015 Quality Management System Certification
ISO 140012015 Environmental Management System certification
ISO 0450012018 Occupational Health and Safety management system certification
AAA level abided by the contract and credit enterprises

PATENTS

Partial



Self-resetting Wall Switch (Invention patent)
Smart control 5 pin socket sensor lamp (Invention patent)
A multifunctional socket capable of adjusting distance (Invention patent)
A power socket with an replaceable sockets modules (Invention patent)
A method for assembling a connect switch base (Invention patent)
A new type of panel (Invention patent)
A smart socket with sensor footlight (invention patent)

GOG electrical

Global Open Genuine

Mission

Deliver safety to hundreds of millions of families around the world

Create value for customers

Help employees develop, Make positive happiness for society

Values

Customer first,
high efficiency, innovation
integrity, responsibility, equality

R SERIES

R30 SERIES

R 11 SERIES

R10 SERIES

R12 SERIES

R13 SERIES

R80 GLASS SERIES

R90 ALUMINUM SERIES

K SERIES

K3 SERIES

K3 GLASS SERIES

K2 SERIES

K5 SERIES

R SERIES SWITCH SOCKET PRODUCTS

Material (panel): PC/GLASS
Size: 86*86mm/86*146mm

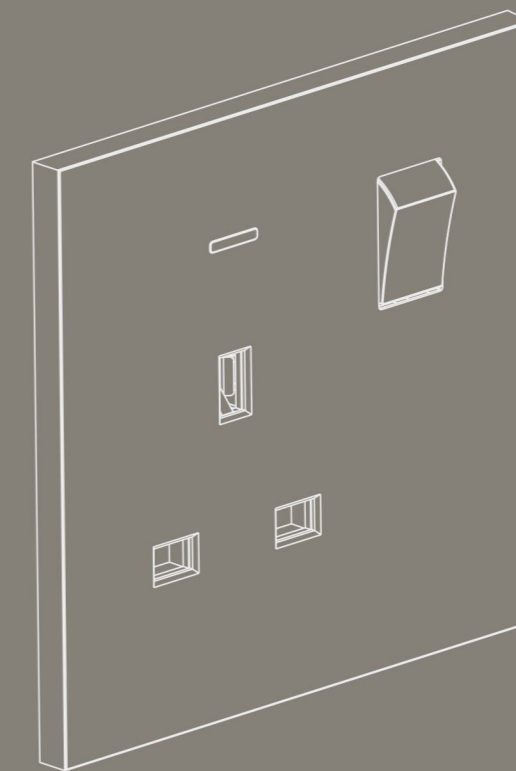

GOElectrical

Zinc alloy supporting frame structure exploded view

R SERIES

Zinc alloy supporting frame structure six views (switch)

- 01**
High strength and highlight fire-retardant PC cover
- 02**
High strength and highlight fire-retardant PC base
- 03**
Invention patent
Slider type transmission structure
- 04**
High strength and highlight fire-retardant material
- 05**
High strength copper parts
- 06**
High strength and highlight fire-retardant material
- 07**
Thickened aluminum sheet

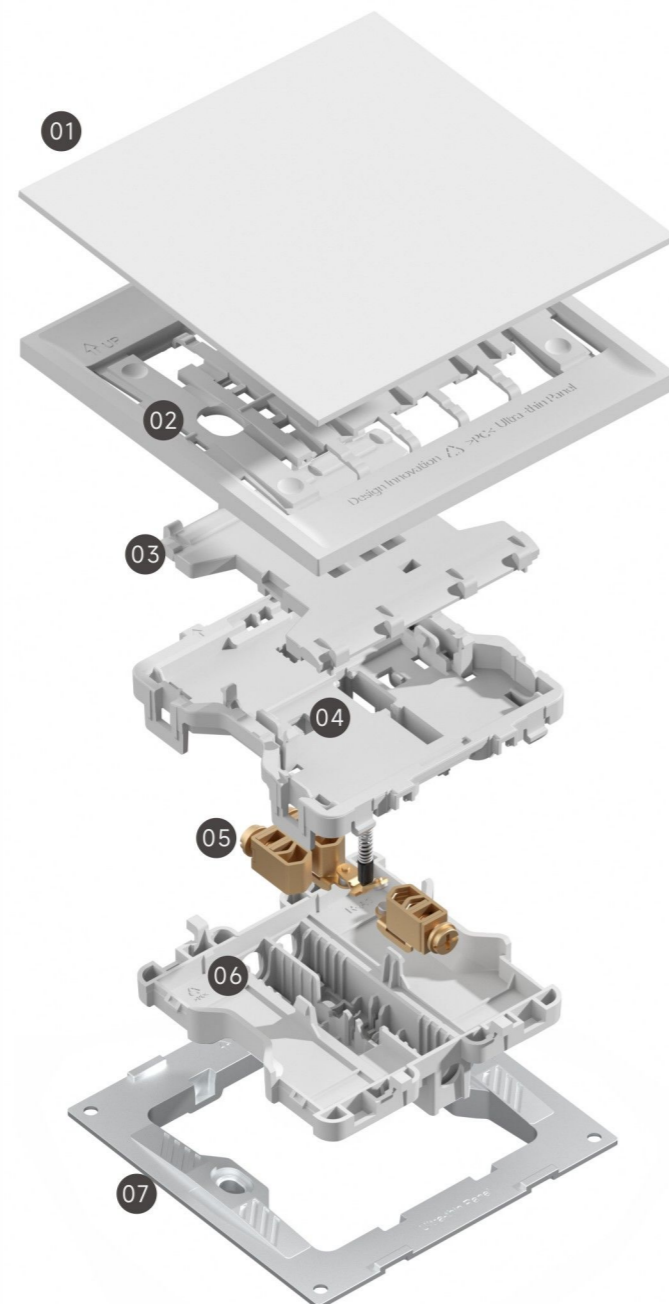

Zinc alloy supporting frame structure six views (socket)

- 01**
High strength and highlight fire-retardant PC cover
- 02**
High strength and highlight fire-retardant PC cover
- 03**
Fiberglass reinforced PA safety door
- 04**
Integrated copper
- 05**
High strength and highlight fire-retardant PC base
- 06**
Thickened aluminum sheet

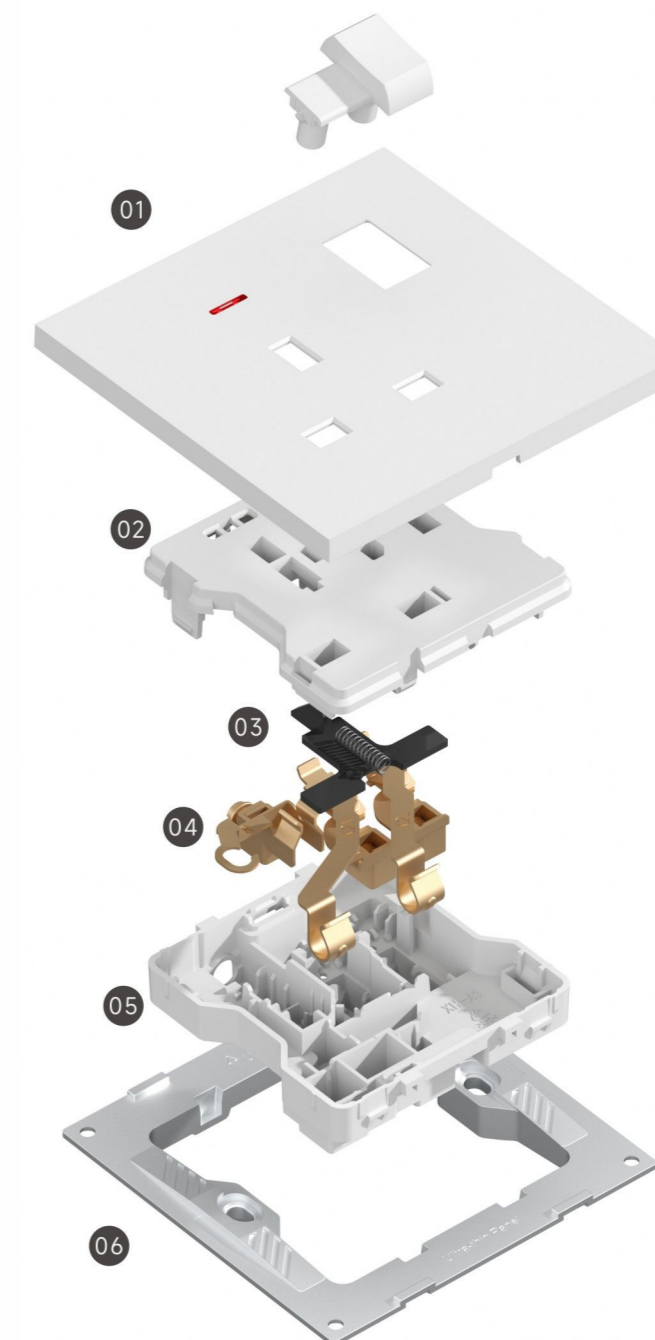

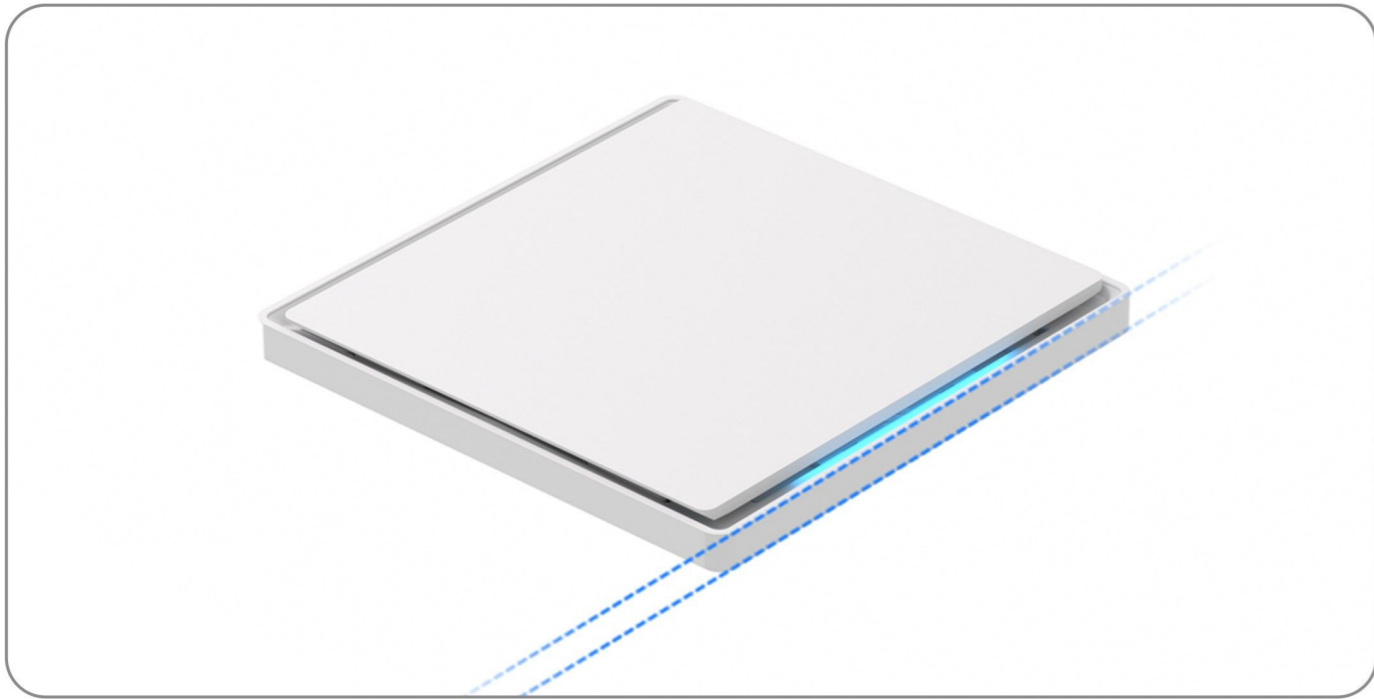

5.8mm Ultra Thin

Thinning into a new realm, simplicity in beauty Creating spatial aesthetics between every inch

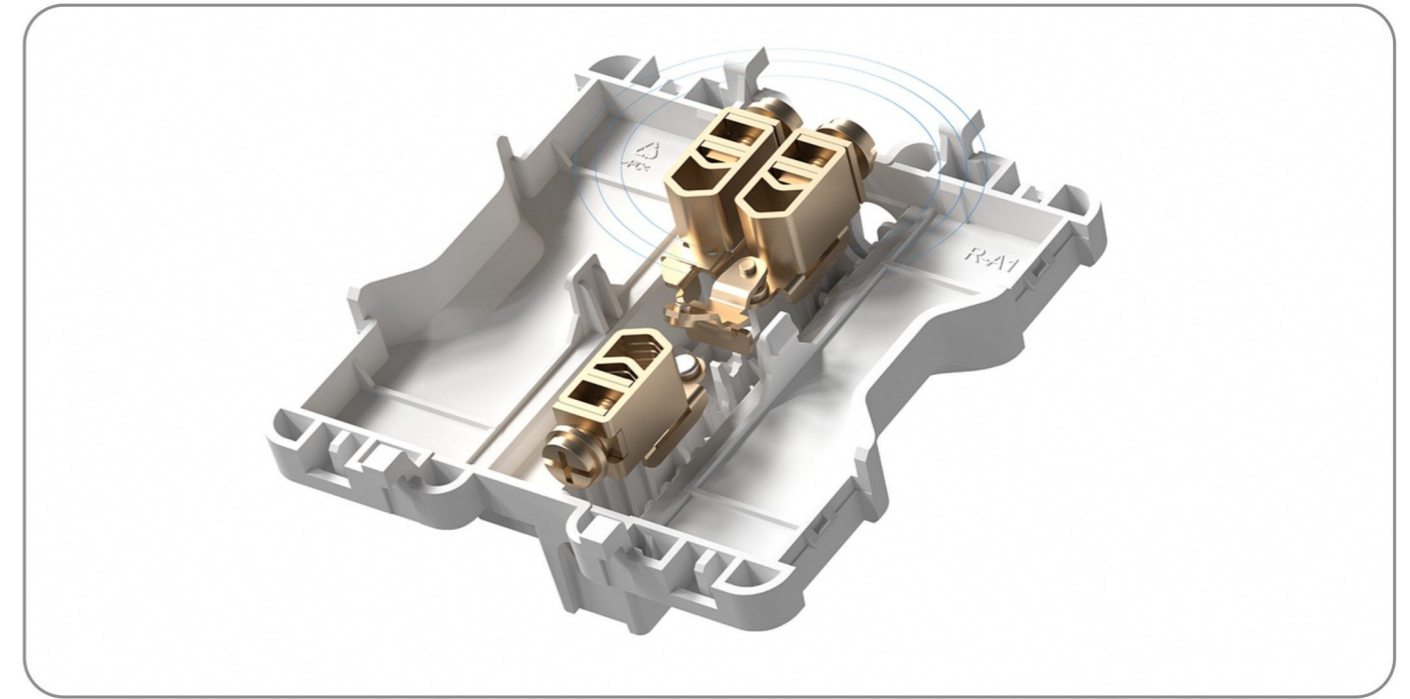

0.35mm thick silver contact

High precision tin phosphorus bronze parts Not easily deformed, smooth insertion and removal, good conductivity

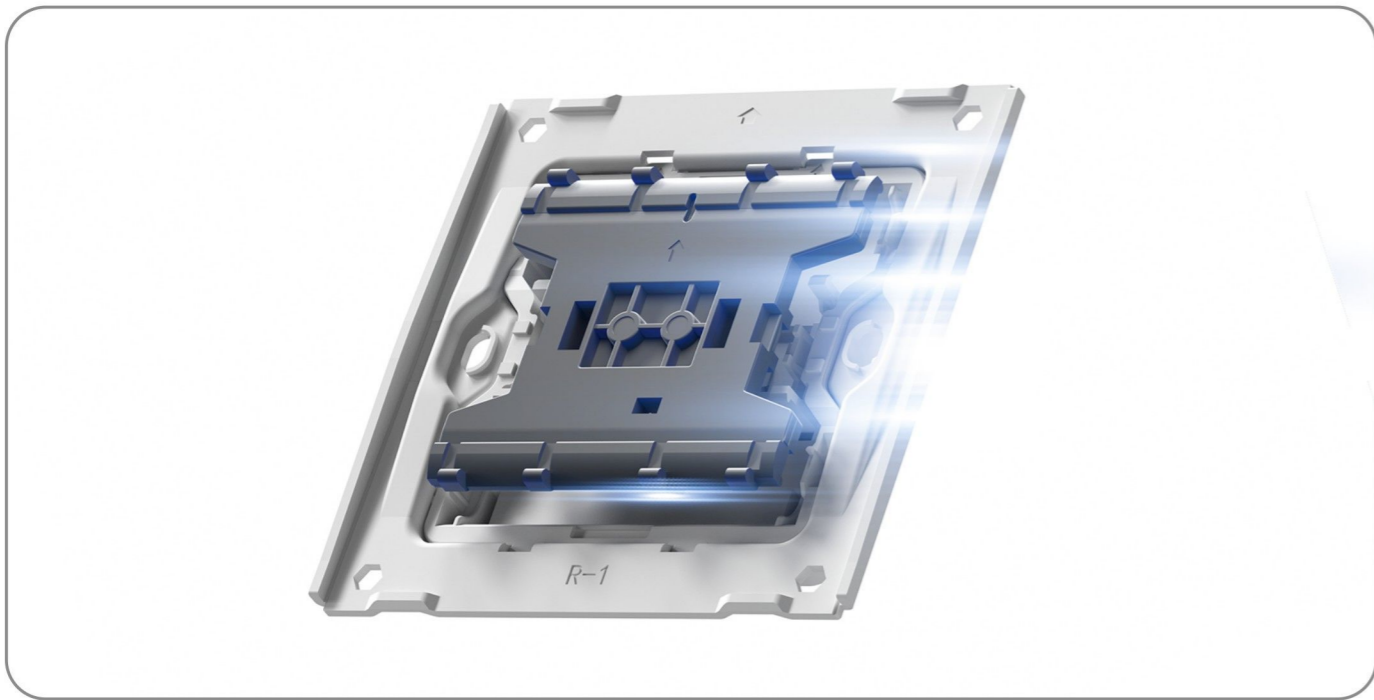

Innovative Slider Structure Patented Structure

Innovative slider structure, the sound is quiet and natural, also the touching is soft and smooth.

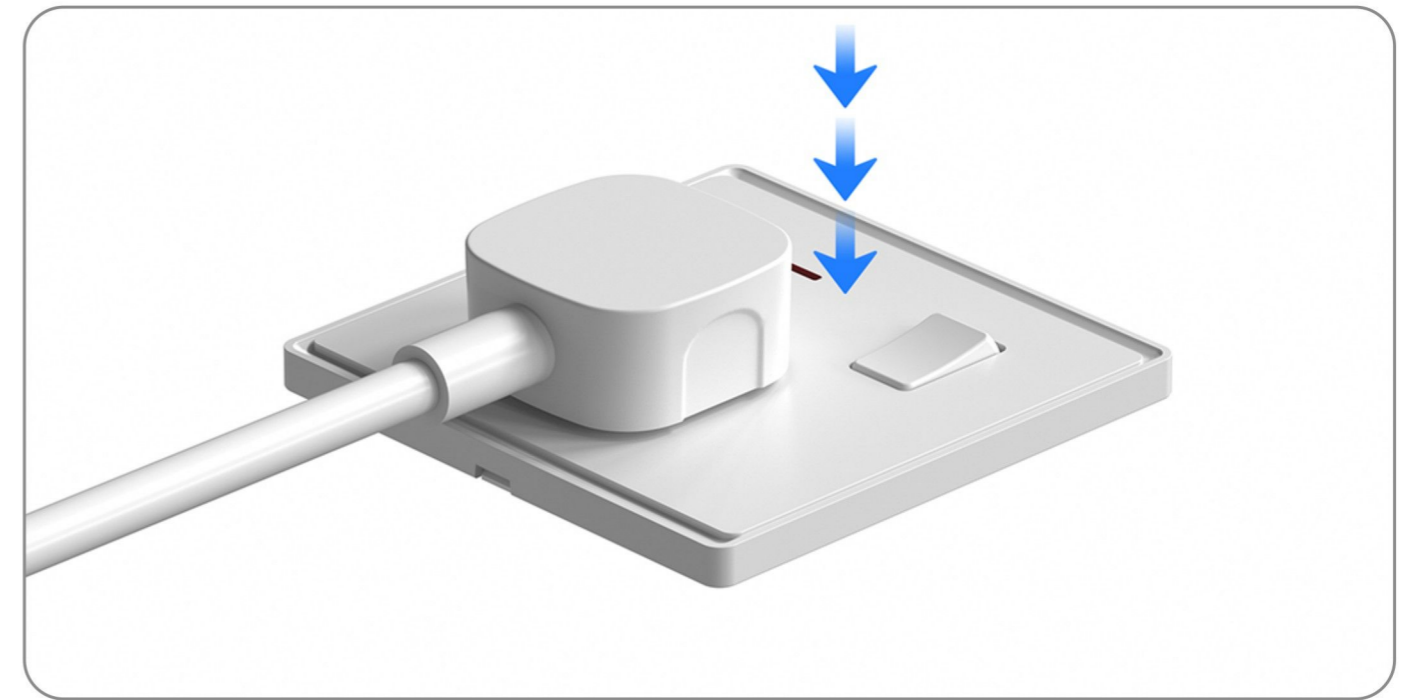

5000 times of plug and unplug resistance

Smooth plug-in board for longer use

R Series Full Product Showcase

Material (panel): PC/GLASS
Size: 86*86mm/86*146mm

● WHITE ● GOLD ● GRAY ● BLACK

R30 SERIES

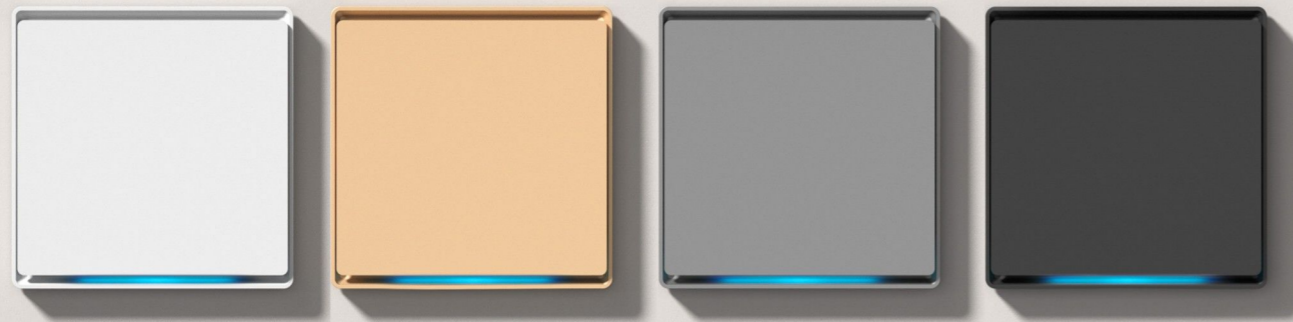

R11 SERIES



R10 SERIES



R12 SERIES

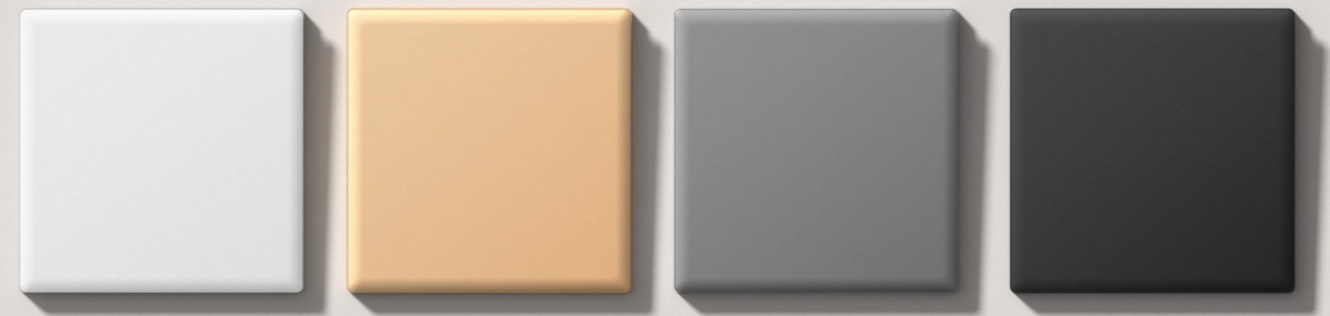

R13 SERIES



R80 GLASS SERIES



R90 ALUMINUM SERIES



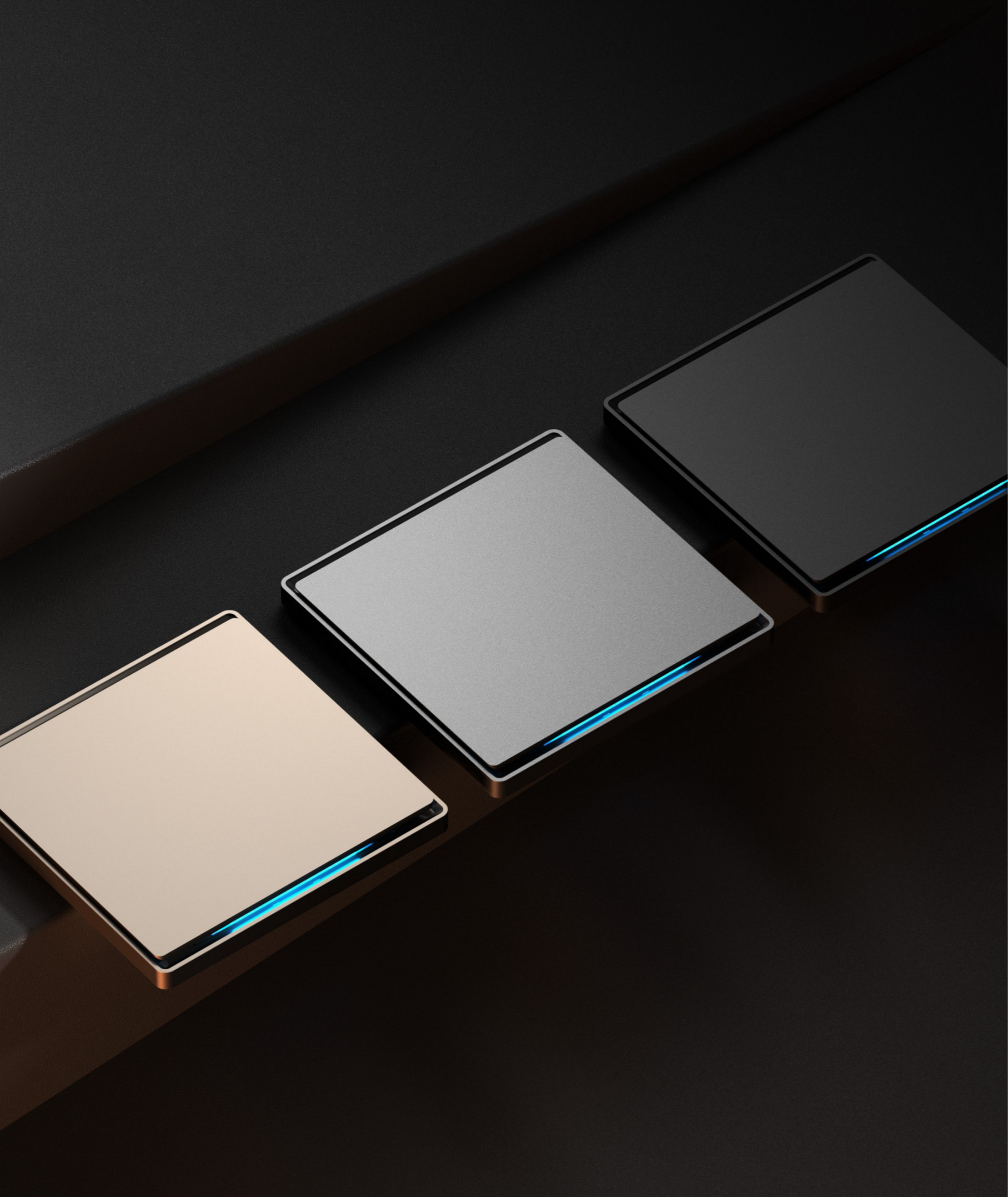

R30 SERIES
SWITCH AND SOCKET

R30 SERIES

SWITCH PRODUCTS



R30301
1 gang 1 way switch

R30302
1 gang 2 way switch



R30313
1 gang intermediate switch



R30303
2 gang 1 way switch

R30304
2 gang 2 way switch



R30305
3 gang 1 way switch

R30306
3 gang 2 way switch

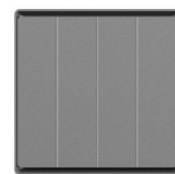

R30307
4 gang 1 way switch

R30308
4 gang 2 way switch



R30317
door bell switch



R30318
door bell switch, with neon

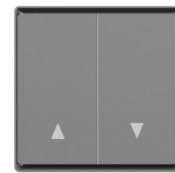

R3316
Curtain switch



R30324
20A double pole switch with neon



R30327
45A double pole switch with neon



R30329
45A double pole switch with neon,146



R30401
Blank plate (86 style)



R30419
13A 1 gang switched fused connection unit, neon



R30420
5A 1 gang switched fused connection unit, neon



R30421
3A 1 gang switched fused connection unit, neon

R30 SERIES

SOCKET PRODUCTS

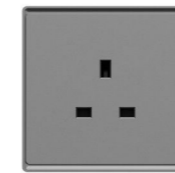

R30403
13A 1 gang unswitched socket

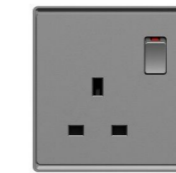

R30405
13A 1 gang switched socket

R30409
13A 1 gang DP switched socket

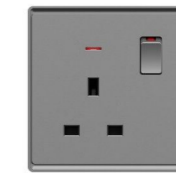

R30407
13A 1 gang switched socket, neon

R30411
13A 1 gang DP switched socket, neon



R30407W
13A 1 gang switched socket,neon,big rocker

R30411W
1 gang DP switched socket,neon,big rocker

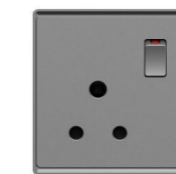

R30429
15A 1 gang switched round pin socket

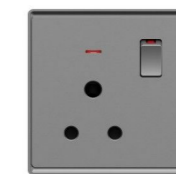

R30431
15A 1 gang switched round pin socket, neon

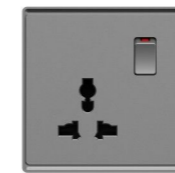

R30405M
13A 1 gang switched MF socket

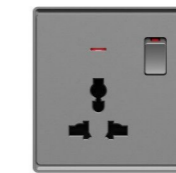

R30407M
13A 1 gang switched MF socket, neon

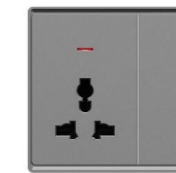

R30407MW
13A 1 gang switched MF socket, neon,big rocker

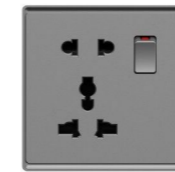

R30475
13A 1 gang switched 5pin MF socket



R30477
13A 1 gang switched 5pin MF socket neon



R30487C-20W
13A 1 gang SP switched socket +1 USB + 1 type C with neon-20W

R30491C-20W
13A 1 gang DP switched socket +1 USB + 1 type C with neon-20W



R30487C
13A 1 gang SP switched socket, 1 USB + 1 type C, neon

R30491C
13A 1 gang DP switched socket, 1 USB + 1 type C, neon

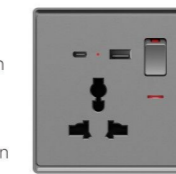

R30587C-20W
1 gang switched MF socket + 1 USB + 1 type C with neon-20W



R30587C
1 gang switched MF socket + 1 USB + 1 type C with neon

PRODUCT COLOUR



White

Gold

Gray

Black

Milky yellow

R30 SERIES

SOCKET PRODUCTS



R30497C
1 gang 5 pin switched
MF socket + 1 USB +
1 type C with neon



R30468
1 gang
German socket

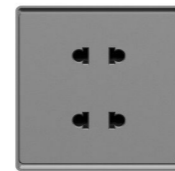

R30461
2x2 pin
socket

TYPE I46 SOCKET PRODUCTS



R30406
13A 2 gang SP switched socket

R30410
13A 2 gang DP switched socket



R30486C
13A 2 gang SP switched socket,
1 USB+1 type C

R30490C
13A 2 gang DP switched socket,
1 USB + 1 type C

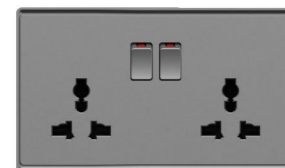

R30406M
13A 2 gang switched MF socket

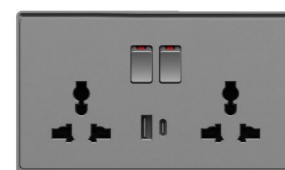

R30586C
13A 2 gang switched MF socket,
1 USB + 1 type C

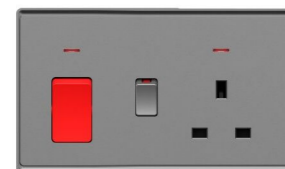

R30331
45A DP switch with neon
+13A switched socket
with neon



R30408
13A 2 gang SP switched
socket, neon

R30412
13A 2 gang DP switched
socket, neon



R30488C
13A 2 gang SP switched
socket, 1 USB+1 type C, neon

R30492C
13A 2 gang DP switched
socket, 1 USB + 1 type C, neon



R30408M
13A 2 gang switched MF
socket, neon



R30588C
13A 2 gang switched MF
socket, 1 USB + 1 type C,
neon



R30402
Blank plate
(I46 style)

R30 SERIES

INFORMATION PRODUCTS



R30355
500W dimmer

R30555
1000W dimmer



R30432
Non isolated TV
socket (INLET)



R30435
TV socket +
telephone socket

R30436
TV socket +data socket



R30453
Duplex telephone socket
RJ11

R30443
Duplex data socket RJ45
(CAT 5E & CAT 6)



R30351
500W stepless fan
control

R30351S
500W 5 steps fan
control



R30442
Data socket RJ45
(CAT 5E & CAT 6)

R30452
Telephone socket
RJ11



R30132
TV socket + satellite
socket



R30322
Key card switch



R30359
1 gang 1 way switch
and 500W stepless fan
control



R30165
Angled satellite
socket (F type)



R30152
Telephone socket +
satellite socket

R30142
Data socket +
satellite socket

PRODUCT COLOUR



White



Gold



Gray



Black



Milky yellow



R11 SERIES

Elegance without boundaries

More aesthetic, more elegant, more functional enables you to fully express your creativity and style. Symbol of lightness, thin and sleek, the new R series range is a breath of fresh air. Each object is a beautiful whole unto itself R series, let your desire for elegance soar.

R11 SERIES

SWITCH PRODUCTS

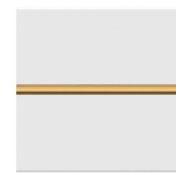

R11301
1 gang 1 way switch

R11302
1 gang 2 way switch



R11313
1 gang intermediate switch

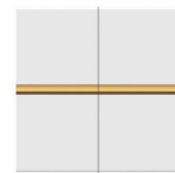

R11303
2 gang 1 way switch

R11304
2 gang 2 way switch

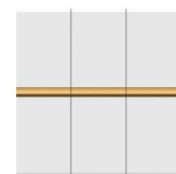

R11305
3 gang 1 way switch

R11306
3 gang 2 way switch

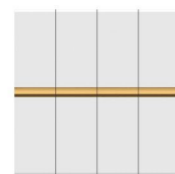

R11307
4 gang 1 way switch

R11308
4 gang 2 way switch

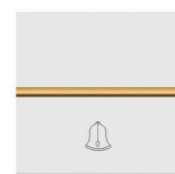

R11317
door bell switch

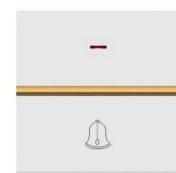

R11318
door bell switch, with neon

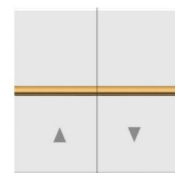

R3316
Curtain switch



R11324
20A double pole switch with neon

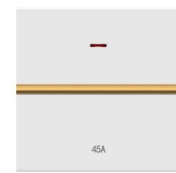

R11327
45A double pole switch with neon



R11329
45A double pole switch with neon,146

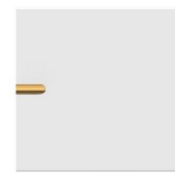

R11401
Blank plate (86 style)

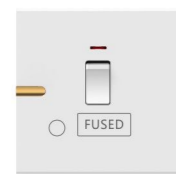

R11419
13A 1 gang switched fused connection unit, neon

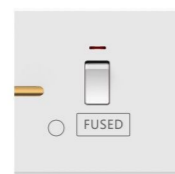

R11420
5A 1 gang switched fused connection unit, neon

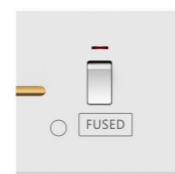

R11421
3A 1 gang switched fused connection unit, neon

R11 SERIES

SOCKET PRODUCTS

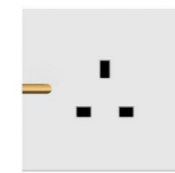

R11403
13A 1 gang unswitched socket

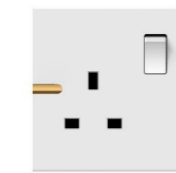

R11405
13A 1 gang switched socket

R11409
13A 1 gang DP switched socket

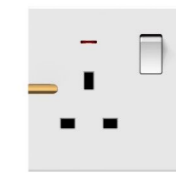

R11407
13A 1 gang switched socket, neon

R11411
13A 1 gang DP switched socket, neon

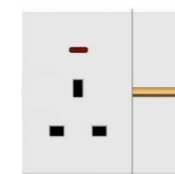

R11407W
13A 1 gang switched socket,neon,big rocker

R11411W
1 gang DP switched socket,neon,big rocker

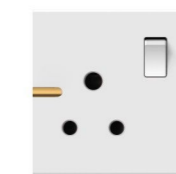

R11429
15A 1 gang switched round pin socket

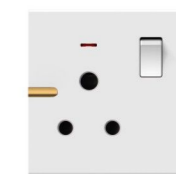

R11431
15A 1 gang switched round pin socket, neon



R11405M
13A 1 gang switched MF socket



R11407M
13A 1 gang switched MF socket, neon

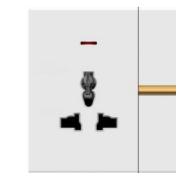

R11407MW
13A 1 gang switched MF socket, neon,big rocker



R11475
13A 1 gang switched 5pin MF socket

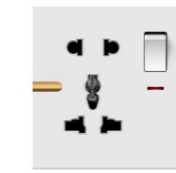

R11477
13A 1 gang switched 5pin MF socket neon

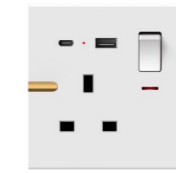

R11487C-20W
13A 1 gang SP switched socket +1 USB + 1 type C with neon-20W

R11491C-20W
13A 1 gang DP switched socket +1 USB + 1 type C with neon-20W

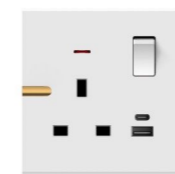

R11487C
13A 1 gang SP switched socket, 1 USB + 1 type C, neon

R11491C
13A 1 gang DP switched socket, 1 USB + 1 type C, neon

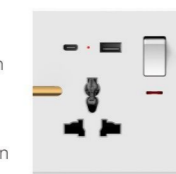

R11587C-20W
1 gang switched MF socket + 1 USB + 1 type C with neon-20W

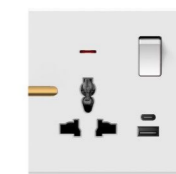

R11587C
1 gang switched MF socket + 1 USB + 1 type C with neon

PRODUCT COLOUR



White

Gold

Gray

Black

Milky yellow

R11 SERIES

SOCKET PRODUCTS



R11497C
1 gang 5 pin switched MF socket + 1 USB + 1 type C with neon



R11468
1 gang German socket

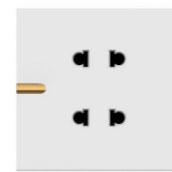

R11461
2x2 pin socket

TYPE 146 SOCKET PRODUCTS

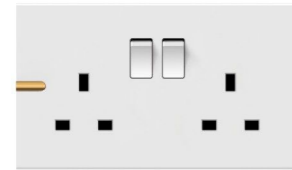

R11406
13A 2 gang SP switched socket

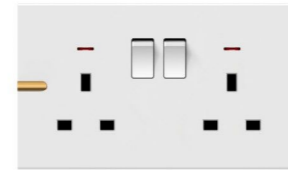

R11408
13A 2 gang SP switched socket, neon

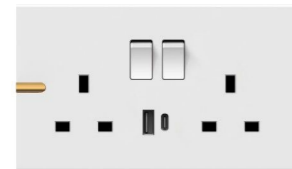

R11486C
13A 2 gang SP switched socket, 1 USB+1 type C

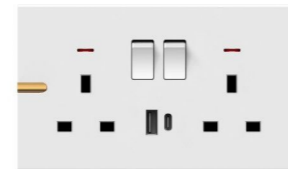

R11412
13A 2 gang DP switched socket, neon

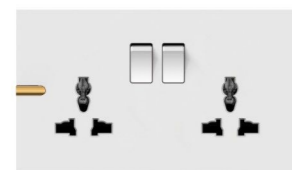

R11406M
13A 2 gang switched MF socket

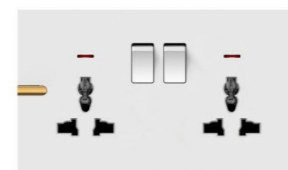

R11488C
13A 2 gang SP switched socket, 1 USB+1 type C, neon

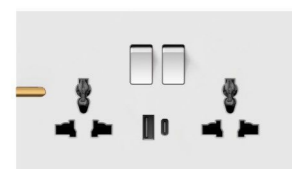

R11586C
13A 2 gang switched MF socket, 1 USB + 1 type C

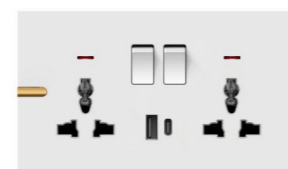

R11492C
13A 2 gang DP switched socket, 1 USB + 1 type C, neon

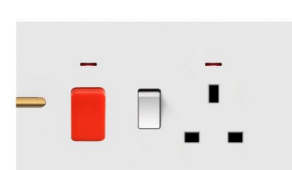

R11331
45A DP switch with neon +13A switched socket with neon

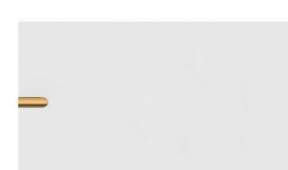

R11402
Blank plate (146 style)

R11 SERIES

INFORMATION PRODUCTS



R11355
500W dimmer



R11351
500W stepless fan control



R11359
1 gang 1 way switch and 500W stepless fan control

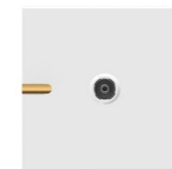

R11555
1000W dimmer



R11351S
500W 5 steps fan control

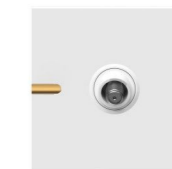

R11165
Angled satellite socket (F type)



R11432
Non isolated TV socket (INLET)

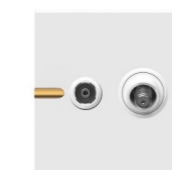

R11442
Data socket RJ45 (CAT 5E & CAT 6)



R11152
Telephone socket + satellite socket



R11435
TV socket + telephone socket



R11452
Telephone socket RJ11



R11142
Data socket + satellite socket



R11453
Duplex telephone socket RJ11



R11322
Key card switch



R11821
45A Cable Outlet



R11436
TV socket + data socket



R11443
Duplex data socket RJ45 (CAT 5E & CAT 6)

PRODUCT COLOUR



R10 SERIES



SWITCH AND SOCKET

More aesthetic, more elegant, more functional enables you to fully express your creativity and style. Symbol of lightness, thin and sleek, the new R series range is a breath of fresh air. Each object is a beautiful whole unto itself R series, let your desire for elegance soar.

R12 SERIES

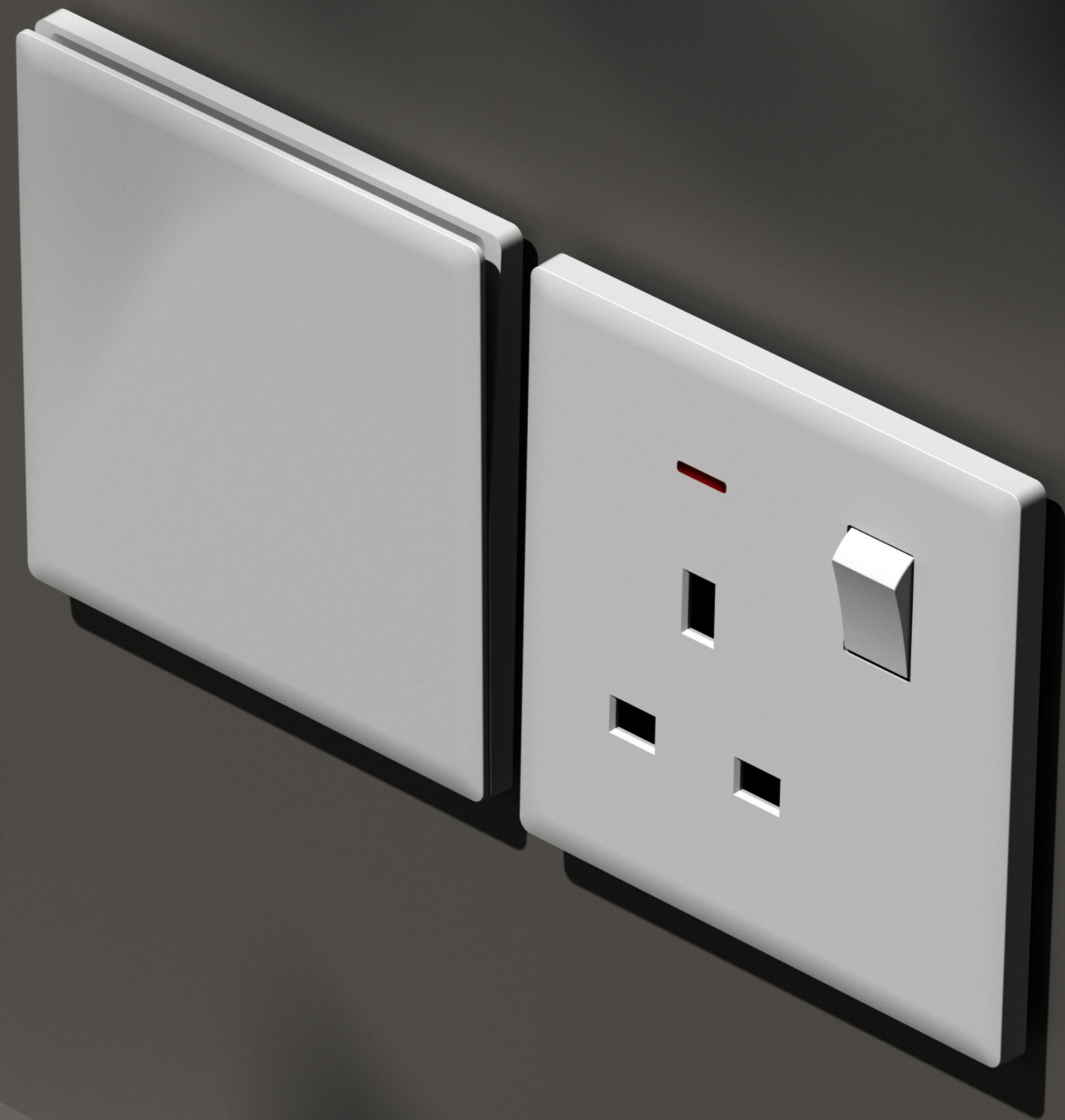

Elegance without boundaries

More aesthetic, more elegant, more functional enables you to fully express your creativity and style. Symbol of lightness, thin and sleek, the new R series range is a breath of fresh air. Each object is a beautiful whole unto itself. R series, let your desire for elegance soar.

R13 SERIES

Elegance without boundaries

More aesthetic, more elegant, more functional enables you to fully express your creativity and style. Symbol of lightness, thin and sleek, the new R series range is a breath of fresh air. Each object is a beautiful whole unto itself. R series, let your desire for elegance soar.





R80 GALSS SERIES

R90 ALUMINUM SERIES

More aesthetic, more elegant, more functional enables you to fully express your creativity and style. Symbol of lightness, thin and sleek, the new R series range is a breath of fresh air. Each object is a beautiful whole unto itself R series, let your desire for elegance soar.



R SERIES

SWITCH PRODUCTS

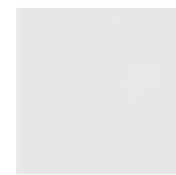

R10301
1 gang 1 way switch

R10302
1 gang 2 way switch

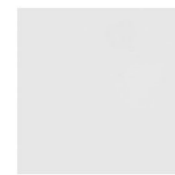

R10313
1 gang intermediate switch



R10303
2 gang 1 way switch

R10304
2 gang 2 way switch

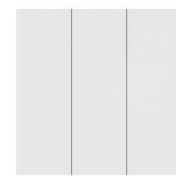

R10305
3 gang 1 way switch

R10306
3 gang 2 way switch



R10307
4 gang 1 way switch

R10308
4 gang 2 way switch

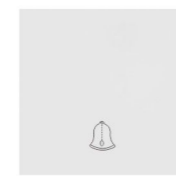

R10317
door bell switch

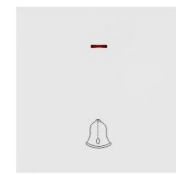

R10318
door bell switch, with neon



R3316
Curtain switch



R10324
20A double pole switch with neon



R10327
45A double pole switch with neon



R10329
45A double pole switch with neon,146



R10401
Blank plate (86 style)

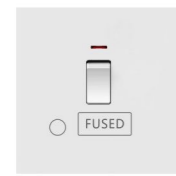

R10419
13A 1 gang switched fused connection unit, neon

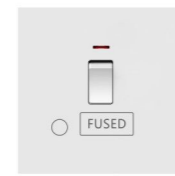

R10420
5A 1 gang switched fused connection unit, neon

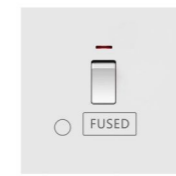

R10421
3A 1 gang switched fused connection unit, neon

R SERIES

SOCKET PRODUCTS



R10403
13A 1 gang unswitched socket

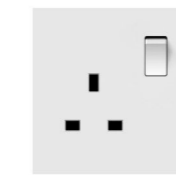

R10405
13A 1 gang switched socket

R10409
13A 1 gang DP switched socket

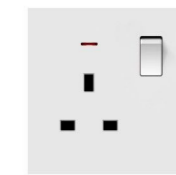

R10407
13A 1 gang switched socket, neon

R10411
13A 1 gang DP switched socket, neon

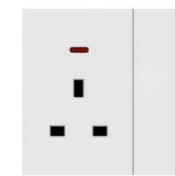

R10407W
13A 1 gang switched socket,neon,big rocker

R10411W
1 gang DP switched socket,neon,big rocker

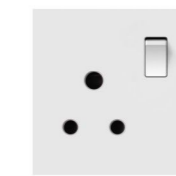

R10429
15A 1 gang switched round pin socket

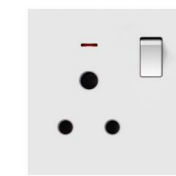

R10431
15A 1 gang switched round pin socket, neon



R10405M
13A 1 gang switched MF socket



R10407M
13A 1 gang switched MF socket, neon



R10407MW
13A 1 gang switched MF socket, neon,big rocker

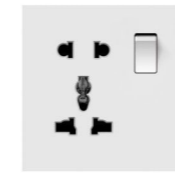

R10475
13A 1 gang switched 5pin MF socket

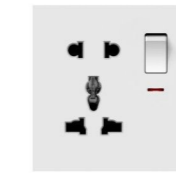

R10477
13A 1 gang switched 5pin MF socket neon

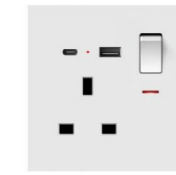

R10487C-20W
13A 1 gang SP switched socket +1 USB + 1 type C with neon-20W

R10491C-20W
13A 1 gang DP switched socket +1 USB + 1 type C with neon-20W

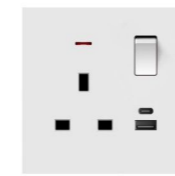

R10487C
13A 1 gang SP switched socket, 1 USB + 1 type C, neon

R10491C
13A 1 gang DP switched socket, 1 USB + 1 type C, neon

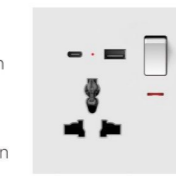

R10587C-20W
1 gang switched MF socket + 1 USB + 1 type C with neon-20W



R10587C
1 gang switched MF socket + 1 USB + 1 type C with neon

PRODUCT COLOUR



White

Gold

Gray

Black

Milky yellow

R SERIES

SOCKET PRODUCTS



R10497C
1 gang 5 pin switched MF socket + 1 USB + 1 type C with neon



R10468
1 gang German socket

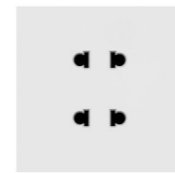

R10461
2x2 pin socket

TYPE I46 SOCKET PRODUCTS

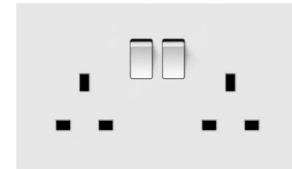

R10406
13A 2 gang SP switched socket

R10410
13A 2 gang DP switched socket

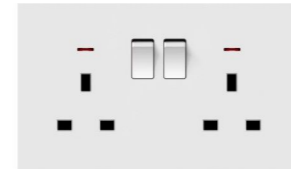

R10408
13A 2 gang SP switched socket, neon

R10412
13A 2 gang DP switched socket, neon

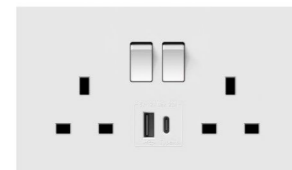

R10486C
13A 2 gang SP switched socket, 1 USB+1 type C

R10490C
13A 2 gang DP switched socket, 1 USB + 1 type C

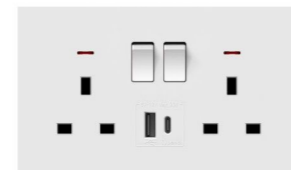

R10488C
13A 2 gang SP switched socket, 1 USB+1 type C, neon

R10492C
13A 2 gang DP switched socket, 1 USB + 1 type C, neon

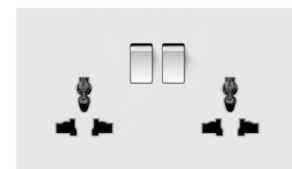

R10406M
13A 2 gang switched MF socket

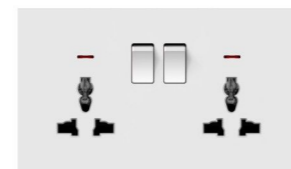

R10408M
13A 2 gang switched MF socket, neon

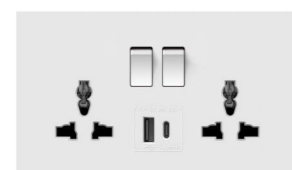

R10586C
13A 2 gang switched MF socket, 1 USB + 1 type C

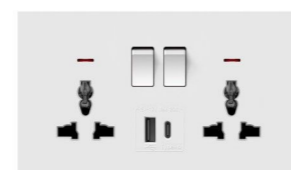

R10588C
13A 2 gang switched MF socket, 1 USB + 1 type C, neon

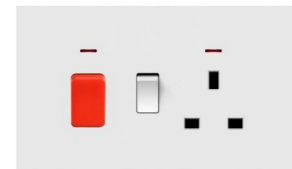

R10331
45A DP switch with neon +13A switched socket with neon

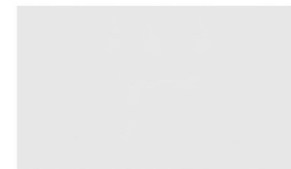

R10402
Blank plate (I46 style)

R SERIES

INFORMATION PRODUCTS



R10355
500W dimmer

R10555
1000W dimmer



R10351
500W stepless fan control

R10351S
500W 5 steps fan control



R10359
1 gang 1 way switch and 500W stepless fan control

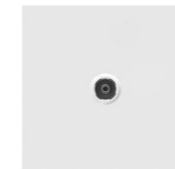

R10432
Non isolated TV socket (INLET)

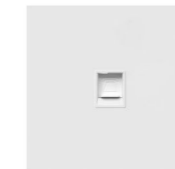

R10442
Data socket RJ45 (CAT 5E & CAT 6)

R10452
Telephone socket RJ11

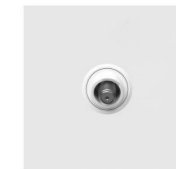

R10165
Angled satellite socket (F type)



R10435
TV socket + telephone socket

R10436
TV socket + data socket



R10132
TV socket + satellite socket



R10152
Telephone socket + satellite socket

R10142
Data socket + satellite socket



R10453
Duplex telephone socket RJ11

R10443
Duplex data socket RJ45 (CAT 5E & CAT 6)



R10322
Key card switch



R10821
45A Cable Outlet

PRODUCT COLOUR

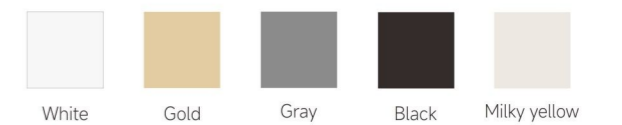

K SERIES SWITCH SOCKET PRODUCTS

Material (panel): PC/GLASS
Size: 86*86mm/86*146mm

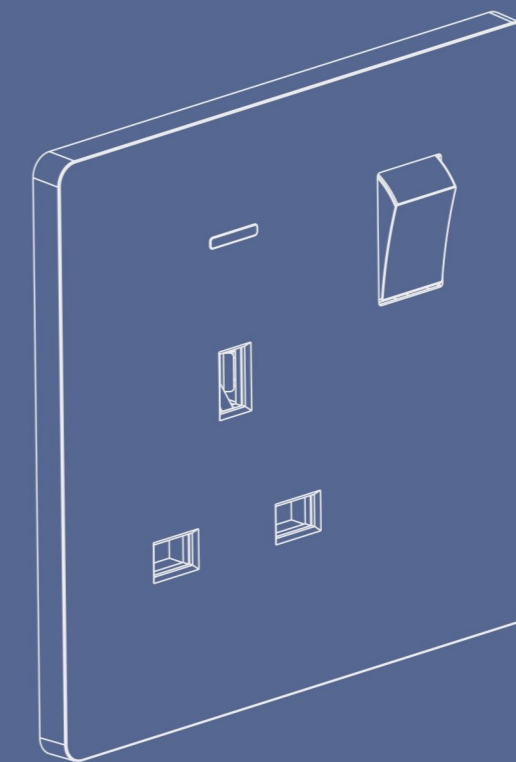

GOElectrical

Metal & plastic supporting frame structure exploded view

Riveting Technology

- 01**
High strength and highlight fire-retardant PC cover
- 02**
Invention patent
Global Pioneer First-Level Transmission Structure
- 03**
High strength and highlight fire-retardant PC cover
- 04**
The latest vertical structure design, 200,000 times super long working life
- 05**
High strength and highlight fire-retardant PC base
- 06**
Invention patent
Riveting technology
- 07**
Thickened Metal supporting frame

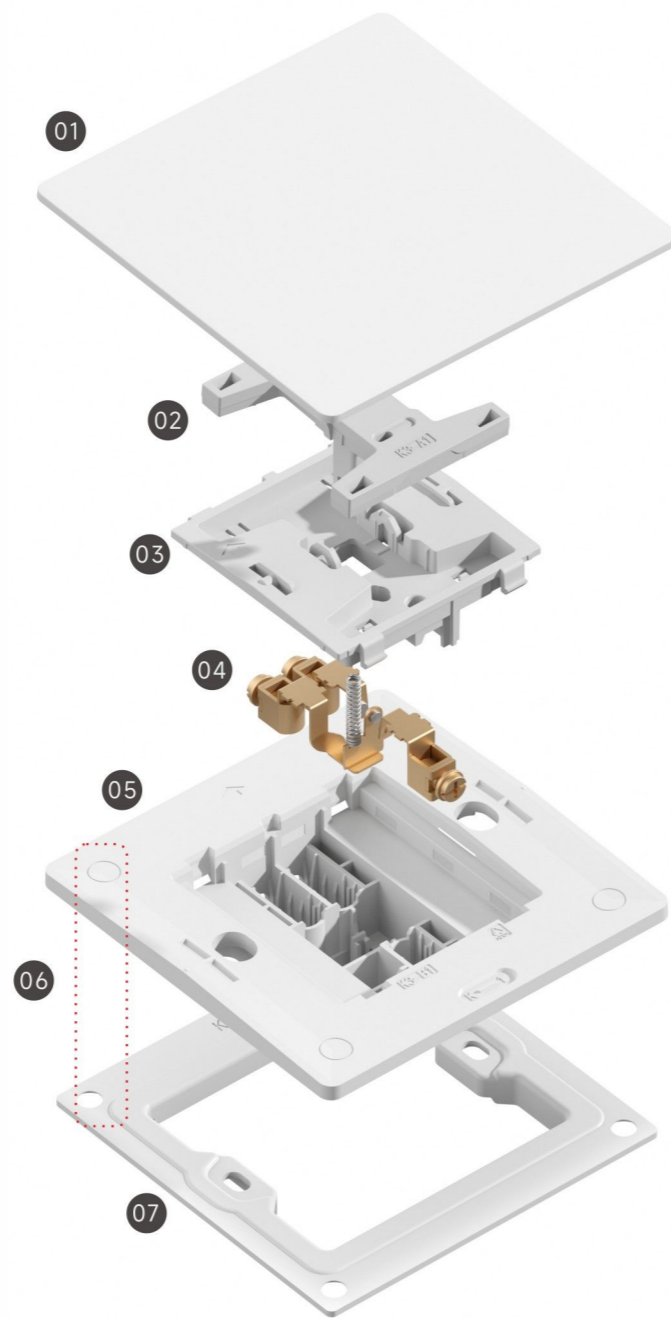

Plastic supporting frame structure exploded view

Metal & plastic supporting frame structure six views (switch)

- 01**
High strength and highlight fire-retardant PC cover
- 02**
I shape moving part, Single-stage driving
- 03**
High strength and highlight fire-retardant PC cover
- 04**
The latest vertical structure design, 200,000 times super long working life
- 05**
Full plastic conjoined structure

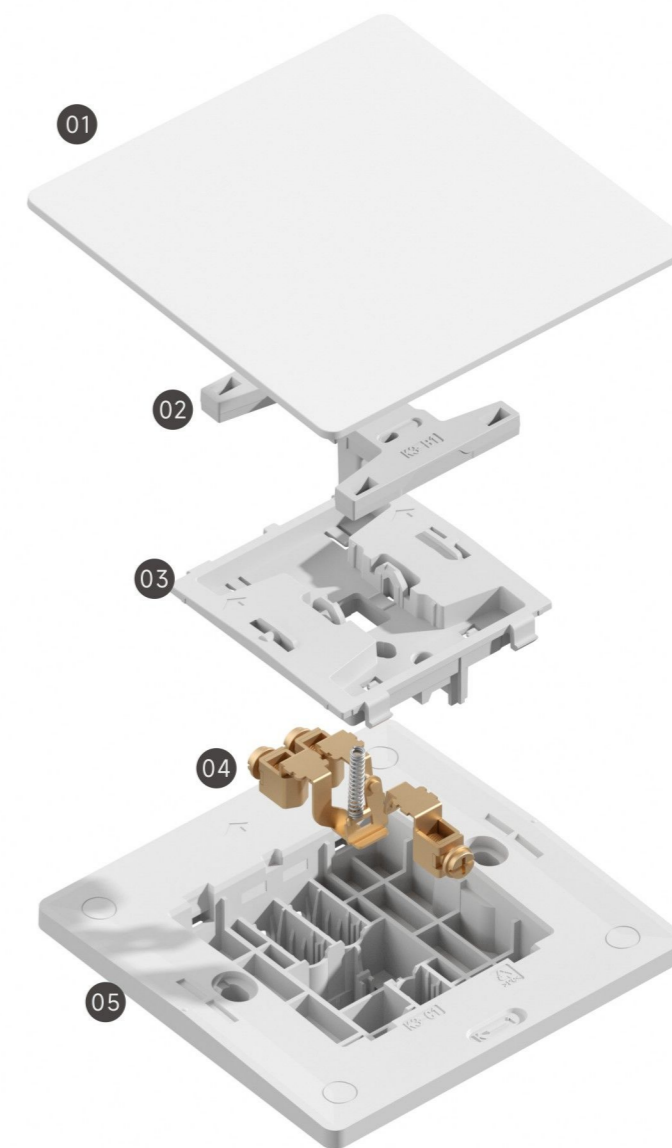

Product Rear Seat Display



Hot Riveting Metal Plate Base

Steel-plastic structure connected by hot riveted iron plates. The deformation of the base is effectively controlled even during violent installation, which greatly improves the overall safety and safety, preventing the switch from being inoperable due to improper installation.



Full Plastic Base

Abandon the traditional buckle design, all-plastic connecting center plate back base structure. The deformation of the base is effectively controlled even during violent installation, which greatly improves the overall safety and safety, preventing the switch from being inoperable due to improper installation.

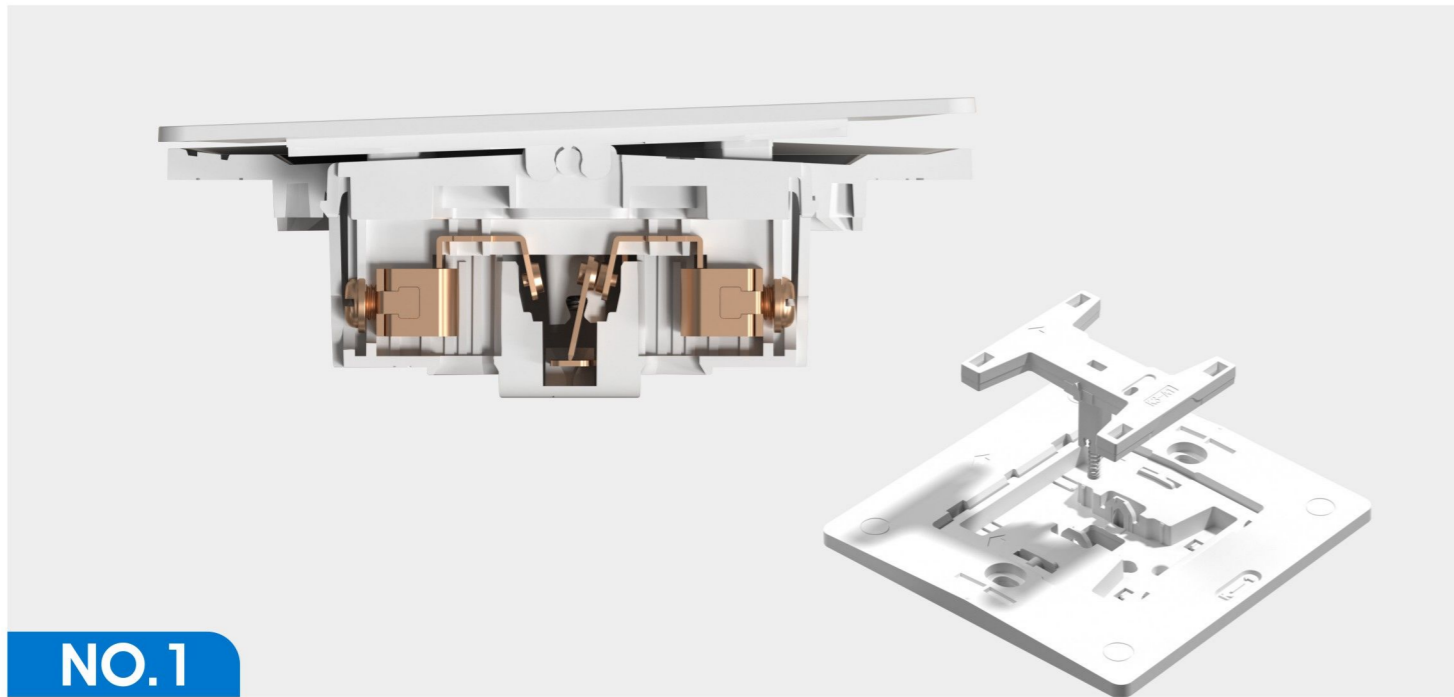

NO.1

VERTICAL STRUCTURE

The movable contact and the stationary contact are engaged by pressing a spring, enabling the switch to open and close. The mechanical switch lifetimes can reach up to **200,000** cycles, significantly extending the service life. It is **5** times the conventional IEC standard.

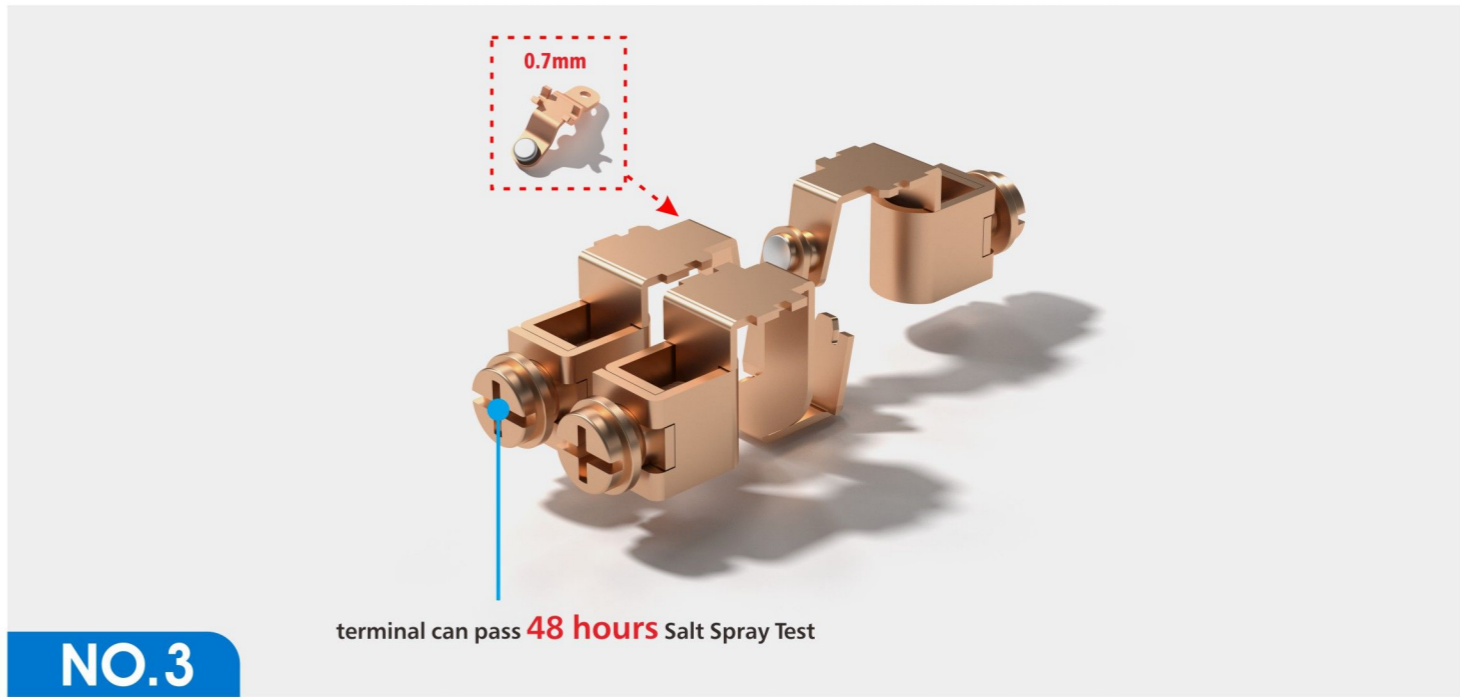

NO.3

STANDARD:

switches typically offer higher durability and reliability, providing better protection against overloads and short circuits, which enhances electrical safety. They can withstand high inrush currents, making them suitable for controlling high-power devices like crystal chandeliers and high-wattage LED lights.

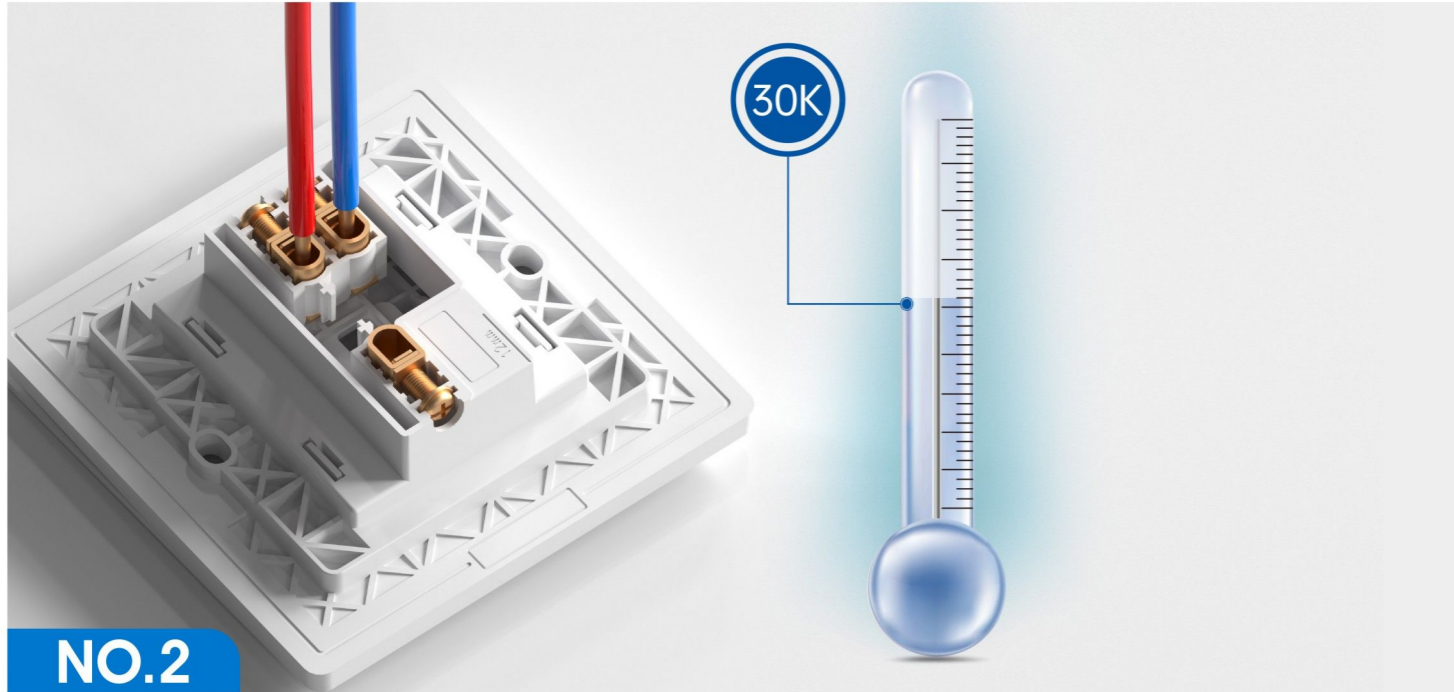

NO.2

TEMPERATURE RISE PERFORMANCE.

According to test results, the temperature rise of our switches is only **30K**, significantly lower than the IEC standard of 45K. This means our switches generate less heat during high current or prolonged use, greatly enhancing safety and reliability.

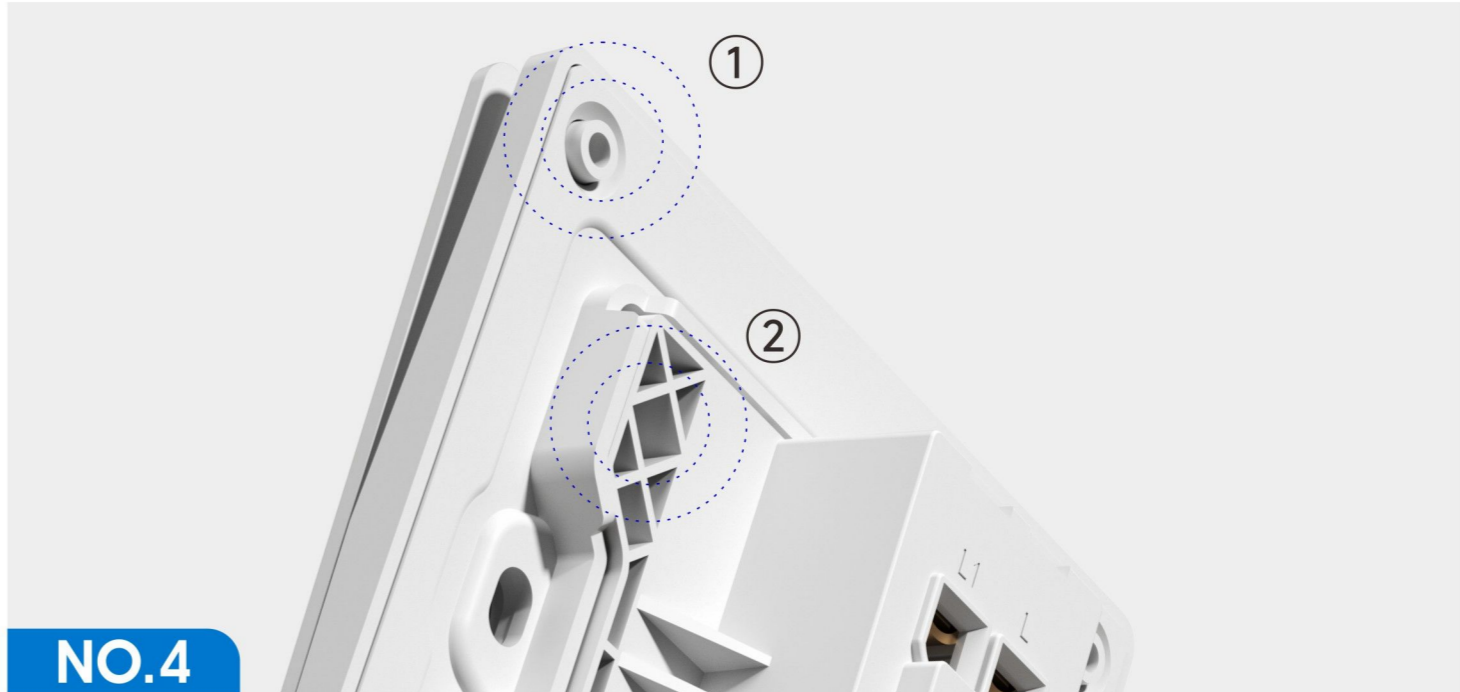

NO.4

- ① The "hot riveting" technology for the base abandons the traditional buckle structure and connects the base to the middle frame using hot riveting. During installation, even if the base plate deforms, the overall shape will not undergo significant changes, greatly enhancing overall safety performance.
- ② Integrated base and middle plate structure with strengthen honeycomb base support high quality for products.

K Series Full Product Showcase

Material (panel): PC/GLASS
Size: 86*86mm/86*146mm

K3 PC SERIES



WHITE

GOLD

GRAY

BLACK

K2 SERIES



WHITE

GOLD

GRAY

BLACK

K3 GLASS SERIES



WHITE

GOLD

GRAY

BLACK

K5 SERIES



WHITE

GOLD

GRAY

BLACK

K3 PC SERIES

Appreciating Minimalist Design

The true colors of elegance with ultra-thin design, minimal geometry and an array of colors and finishes, including grey, black, and gold, K wiring devices blend in or stand out elegantly in any decor.





K3 GLASS SERIES

Appreciating Minimalist Design

The true colors of elegance with ultra-thin design, minimal geometry and an array of colors and finishes, including grey, black, and gold, Kwiring devices blend in or stand out elegantly in any decor.

K2 SERIES



Appreciating Minimalist Design

The true colors of elegance with ultra-thin design, minimal geometry and an array of colors and finishes, including grey, black, and gold, K wiring devices blend in or stand out elegantly in any decor.

**Appreciating
Minimalist Design**

The true colors of elegance with ultra-thin design, minimal geometry and an array of colors and finishes, including grey, black, and gold. K wiring devices blend in or stand out elegantly in any decor.

K5 SERIES



K SERIES

SWITCH PRODUCTS



K301
1 gang 1 way switch



K313
1 gang intermediate switch



K303
2 gang 1 way switch

K304
2 gang 2 way switch



K305
3 gang 1 way switch

K306
3 gang 2 way switch



K307
4 gang 1 way switch

K308
4 gang 2 way switch



K317
door bell switch



K318
door bell switch, with neon



K3316
Curtain switch

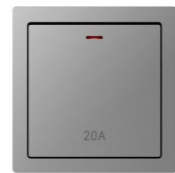

K324
20A double pole switch with neon



K327
45A double pole switch with neon



K329
45A double pole switch with neon, 146



K401
Blank plate (86 style)



K419
13A 1 gang switched fused connection unit, neon



K420
5A 1 gang switched fused connection unit, neon



K421
3A 1 gang switched fused connection unit, neon

K SERIES

SOCKET PRODUCTS



K403
13A 1 gang unswitched socket

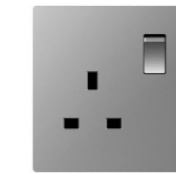

K405
13A 1 gang switched socket

K409
13A 1 gang DP switched socket



K407
13A 1 gang switched socket, neon

K411
13A 1 gang DP switched socket, neon



K407B
13A 1 gang switched socket, neon, big rocker

K411B
1 gang DP switched socket, neon, big rocker



K429
15A 1 gang switched round pin socket



K431
15A 1 gang switched round pin socket, neon



K405M
13A 1 gang switched MF socket



K407M
13A 1 gang switched MF socket, neon



K407MB
13A 1 gang switched MF socket, neon, big rocker



K475
13A 1 gang switched 5pin MF socket



K477
13A 1 gang switched 5pin MF socket neon



K487C-20W
13A 1 gang SP switched socket +1 USB + 1 type C with neon-20W

K491C-20W
13A 1 gang DP switched socket +1 USB + 1 type C with neon-20W



K487C
13A 1 gang SP switched socket, 1 USB + 1 type C, neon

K491C
13A 1 gang DP switched socket, 1 USB + 1 type C, neon



K587C-20W
1 gang switched MF socket + 1 USB + 1 type C with neon-20W



K587C
1 gang switched MF socket + 1 USB + 1 type C with neon

PRODUCT COLOUR



White

Gold

Gray

Black

Milky yellow

K SERIES

SOCKET PRODUCTS



K497C
1 gang 5 pin switched MF socket + 1 USB + 1 type C with neon



K468
1 gang German socket



K460
2 pin socket



K461
2x2 pin socket



K462
1 gang 1 way switch and 2 pin socket

TYPE 146 SOCKET PRODUCTS

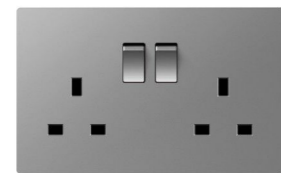

K406
13A 2 gang SP switched socket

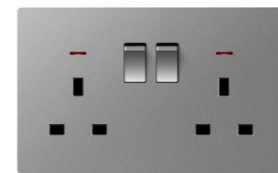

K408
13A 2 gang SP switched socket, neon

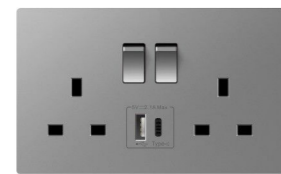

K486C
13A 2 gang SP switched socket, 1 USB+1 type C



K488C
13A 2 gang SP switched socket, 1 USB+1 type C, neon

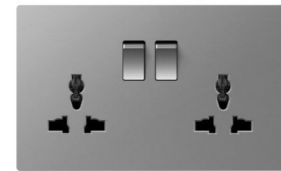

K406M
13A 2 gang switched MF socket

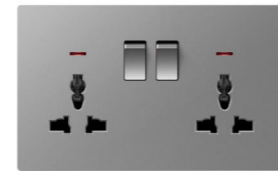

K408M
13A 2 gang switched MF socket, neon

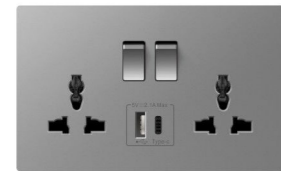

K586C
13A 2 gang switched MF socket, 1 USB + 1 type C



K588C
13A 2 gang switched MF socket, 1 USB + 1 type C, neon

K SERIES

TYPE 146 SOCKET PRODUCTS

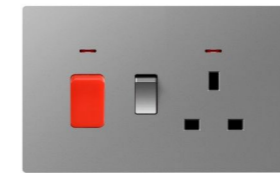

K331
45A DP switch with neon +13A switched socket with neon



K402
Blank plate (146 style)

INFORMATION PRODUCTS



K355
500W dimmer



K351
500W stepless fan control



K359
1 gang 1 way switch and 500W stepless fan control

K555
1000W dimmer

K351S
500W 5 steps fan control



K432
Non isolated TV socket (INLET)



K442
Data socket RJ45 (CAT 5E & CAT 6)



K165
Angled satellite socket (F type)



K435
TV socket + telephone socket



K132
Satellite socket + TV socket



K152
Telephone socket + satellite socket

K436
TV socket + data socket

K142
Data socket + satellite socket



K453
Duplex telephone socket RJ11



K322
Key card switch



K821
45A Cable Outlet

K443
Duplex data socket RJ45 (CAT 5E & CAT 6)

PRODUCT COLOUR

